

# Fundamentals and Applications of Sketch Processing

Mikhail (Misha) Bessmeltsev & Chenxi Liu

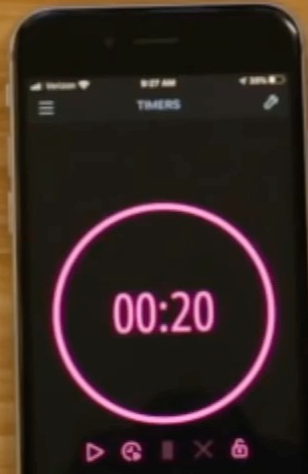

UNIVERSITY OF  
TORONTO



<https://www.youtube.com/watch?v=biT46ugaXmc>

sketches vs photos



Pose reconstruction?



Monocular pose reconstruction  
[Pavlakos et al. 2019]



Monocular pose reconstruction  
[Pavlakos et al. 2019]

# What's so special about sketches?

Broken and overdrawn strokes

Strokes with unclear meaning

Shape and proportions

Nothing is precise

'Wrong' projection



# What's so special about sketches?

**Broken** and overdrawn **strokes**

Strokes with unclear meaning

Shape and proportions

Nothing is precise

'Wrong' projection

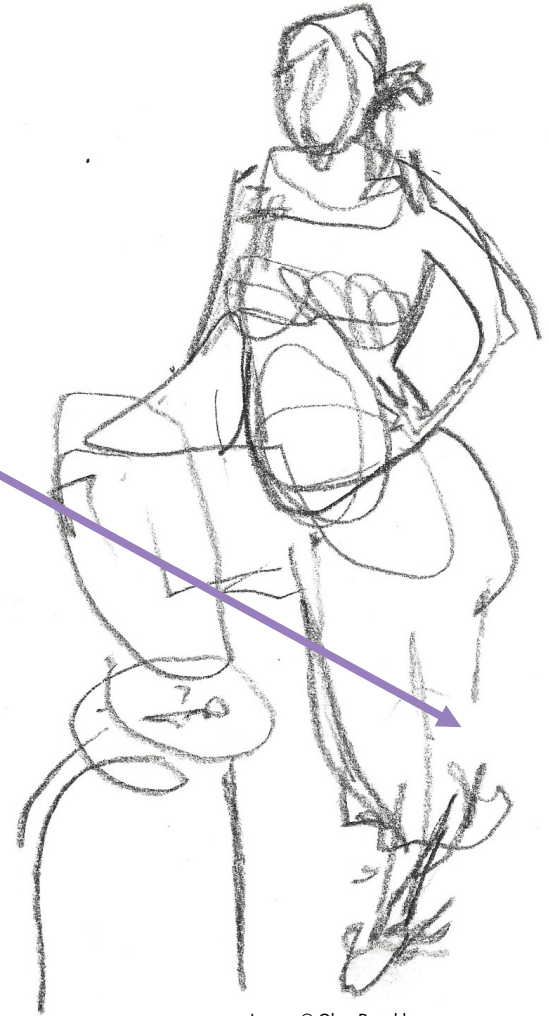



# What's so special about sketches?

Broken and **overdrawn strokes**

Strokes with unclear meaning

Shape and proportions

Nothing is precise

'Wrong' projection



# What's so special about sketches?

Broken and overdrawn strokes

**Strokes with unclear meaning**

Shape and proportions

Nothing is precise

'Wrong' projection



# What's so special about sketches?

Broken and overdrawn strokes

Strokes with unclear meaning

**Shape and proportions**

Nothing is precise

'Wrong' projection



# What's so special about sketches?

Broken and overdrawn strokes

Strokes with unclear meaning

## Shape and proportions

Nothing is precise

'Wrong' projection



Google Quick, draw! dataset



Image: Hasan Gulec

# What's so special about sketches?

Broken and overdrawn strokes

Strokes with unclear meaning

## Shape and proportions

Nothing is precise

'Wrong' projection

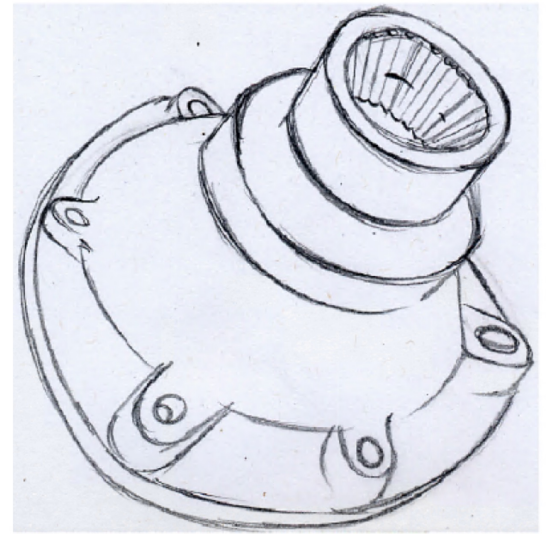

# What's so special about sketches?

Broken and overdrawn strokes

Strokes with unclear meaning

Shape and proportions

**Nothing is precise**

'Wrong' projection

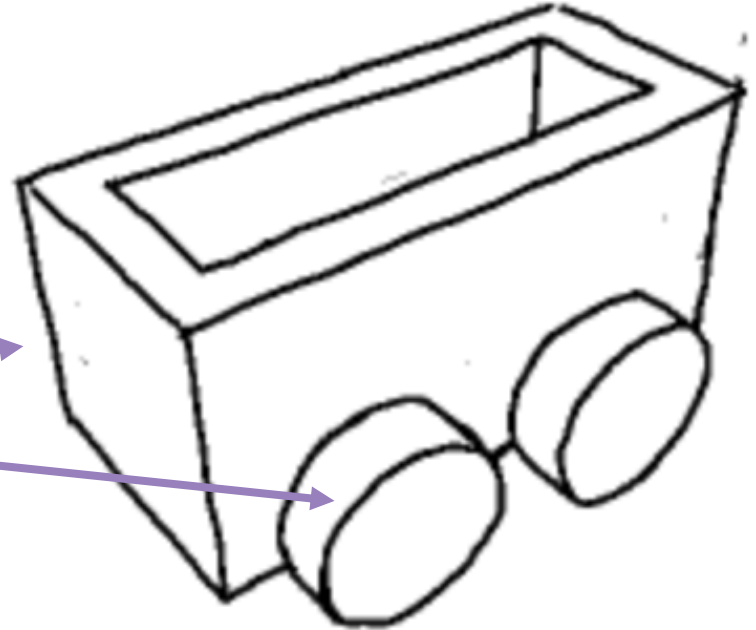

What's so special about sketches?

Broken and overdrawn strokes

Strokes with unclear meaning

Shape and proportions

**Nothing is precise**

'Wrong' projection

A straight  
line?

An ellipse?

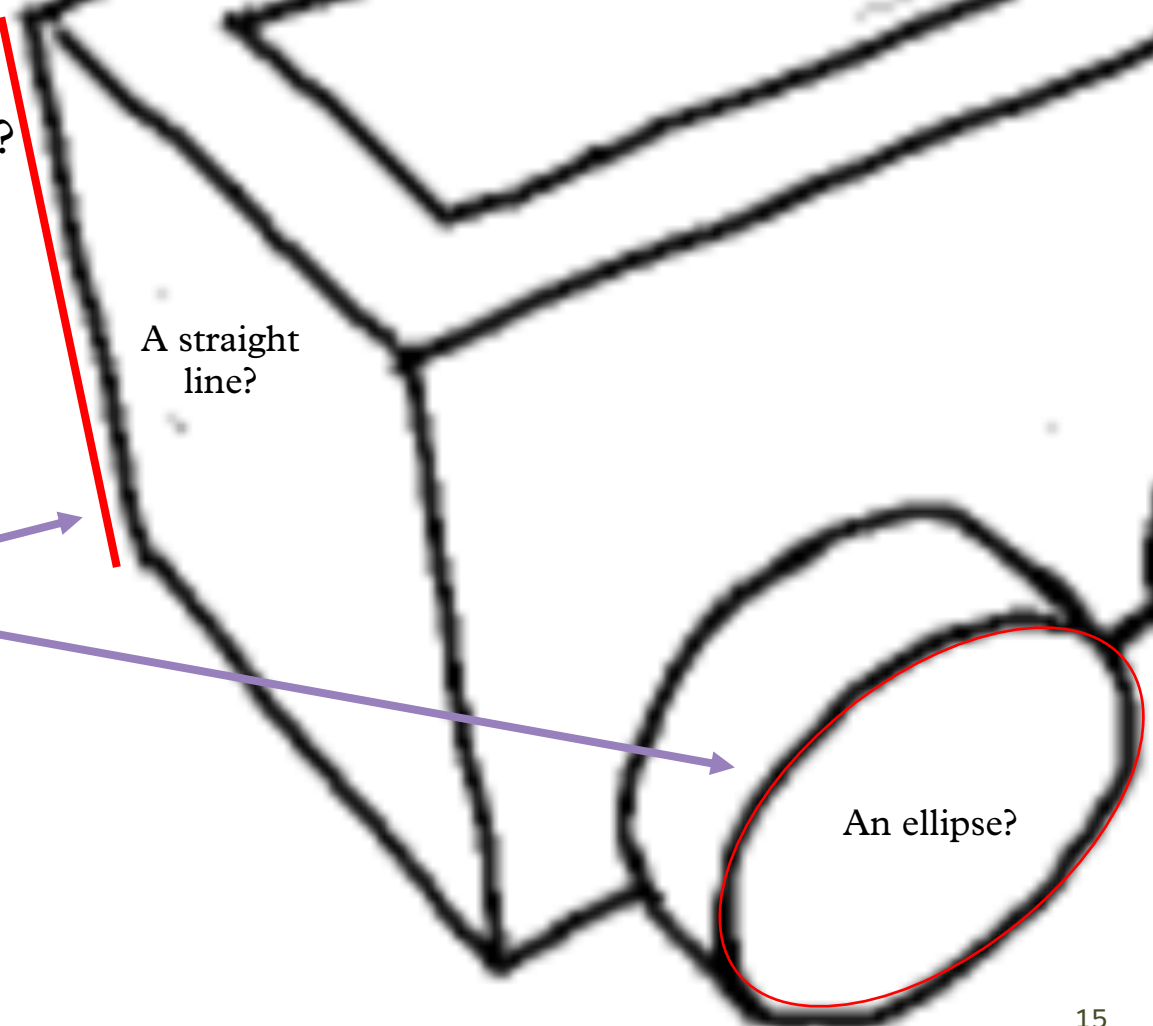

## What's so special about sketches?

Broken and overdrawn strokes

Strokes with unclear meaning

Shape and proportions

**Nothing is precise**

'Wrong' projection

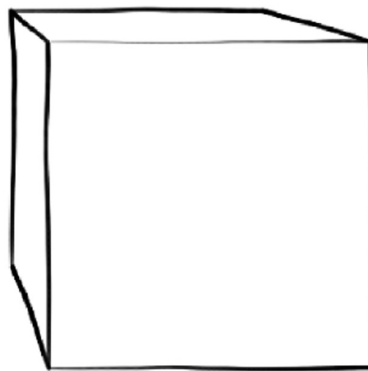

Correct

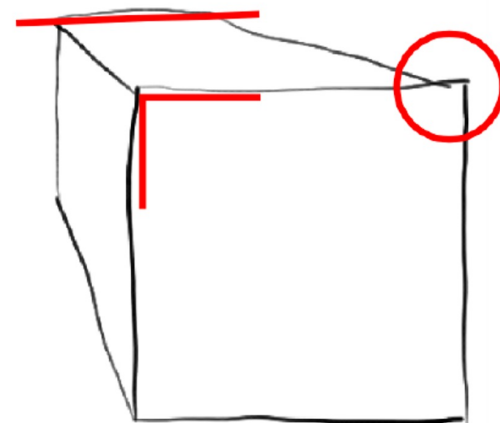

Artist



What's so special about sketches?

Broken and overdrawn strokes

Strokes with unclear meaning

Shape and proportions

Nothing is straight

**'Wrong' projection**

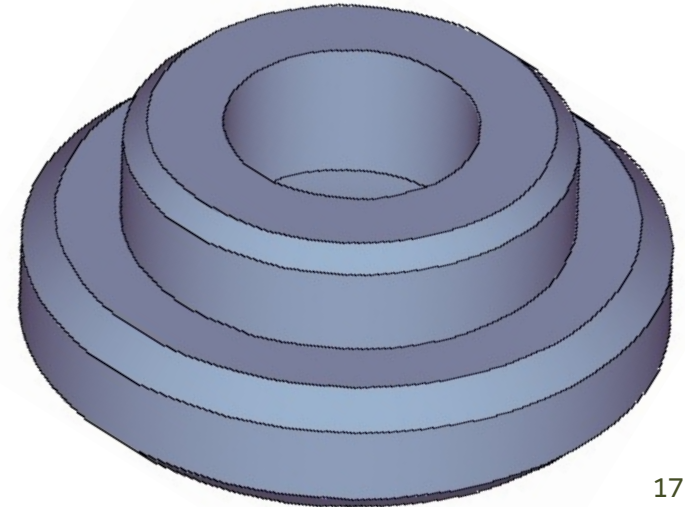
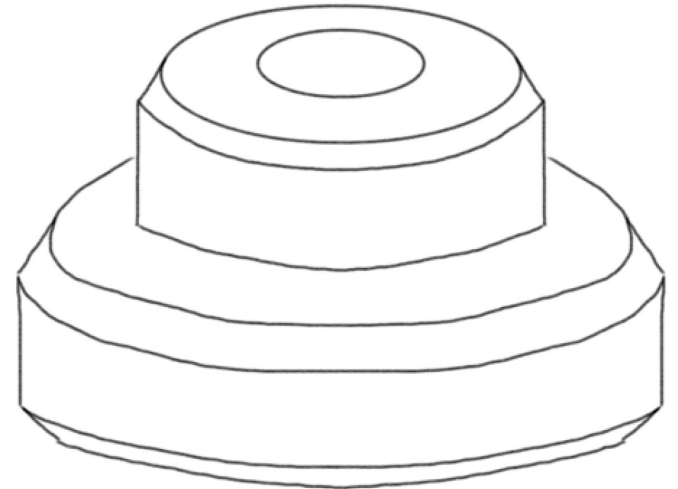

# Projection user study: “Draw a circle in the middle”

Original view

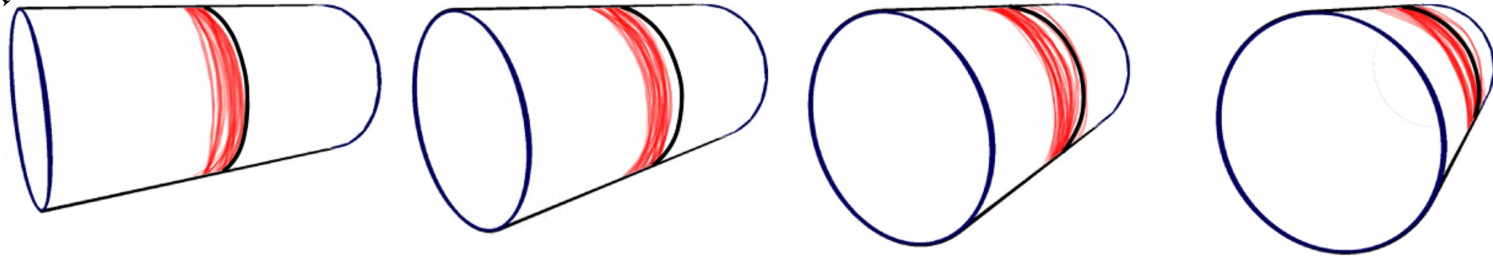

Side view

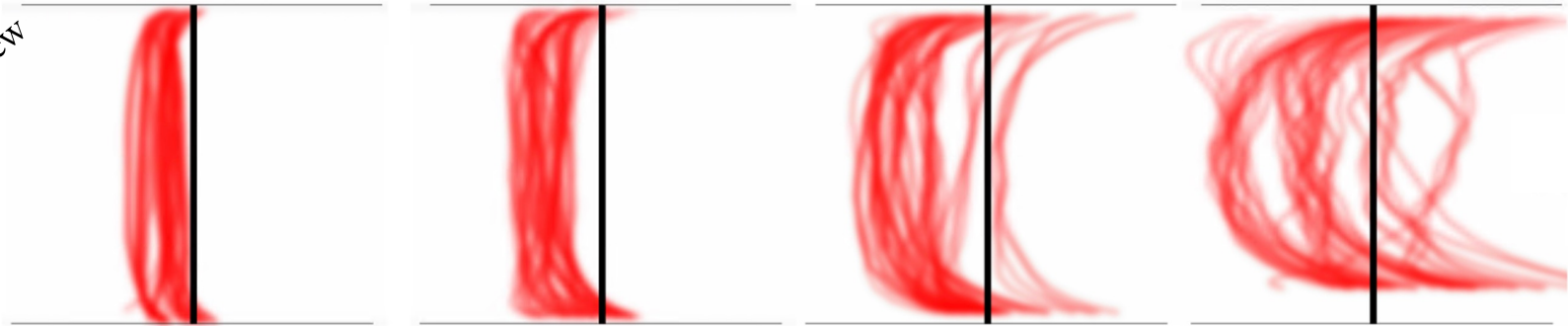

# Linear perspective



Some AI

# Multiperspective



The Pink Studio, Henri Matisse, 1911

# Perception: why is it okay for us?

Maybe humans don't imagine a consistent 3D model while exploring the world?

[Hertzmann, 2024]



# Checkpoint

Sketches are not photos. They are heavily distorted and stylized.

Processing has to be guided by perception/data, not simple metrics

Chamfer distance?  
Hausdorff?  
 $L_2$ ?



A snail (Jacob van Maerlant, c.1350)

stuff inside sketches

# Raster vs vector



<https://www.youtube.com/watch?v=v13hGeSsaBA>

# Clean vs rough vs filled



1,2,4 © Olga Posukh

© Zoska Leutina



# Strokes, endpoints, and junctions



# Junctions and intersections: real and intended

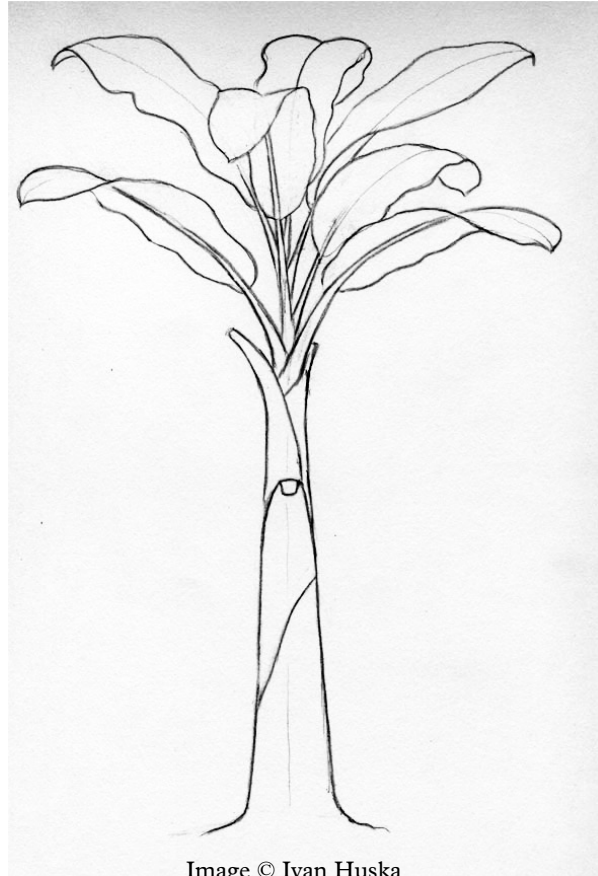
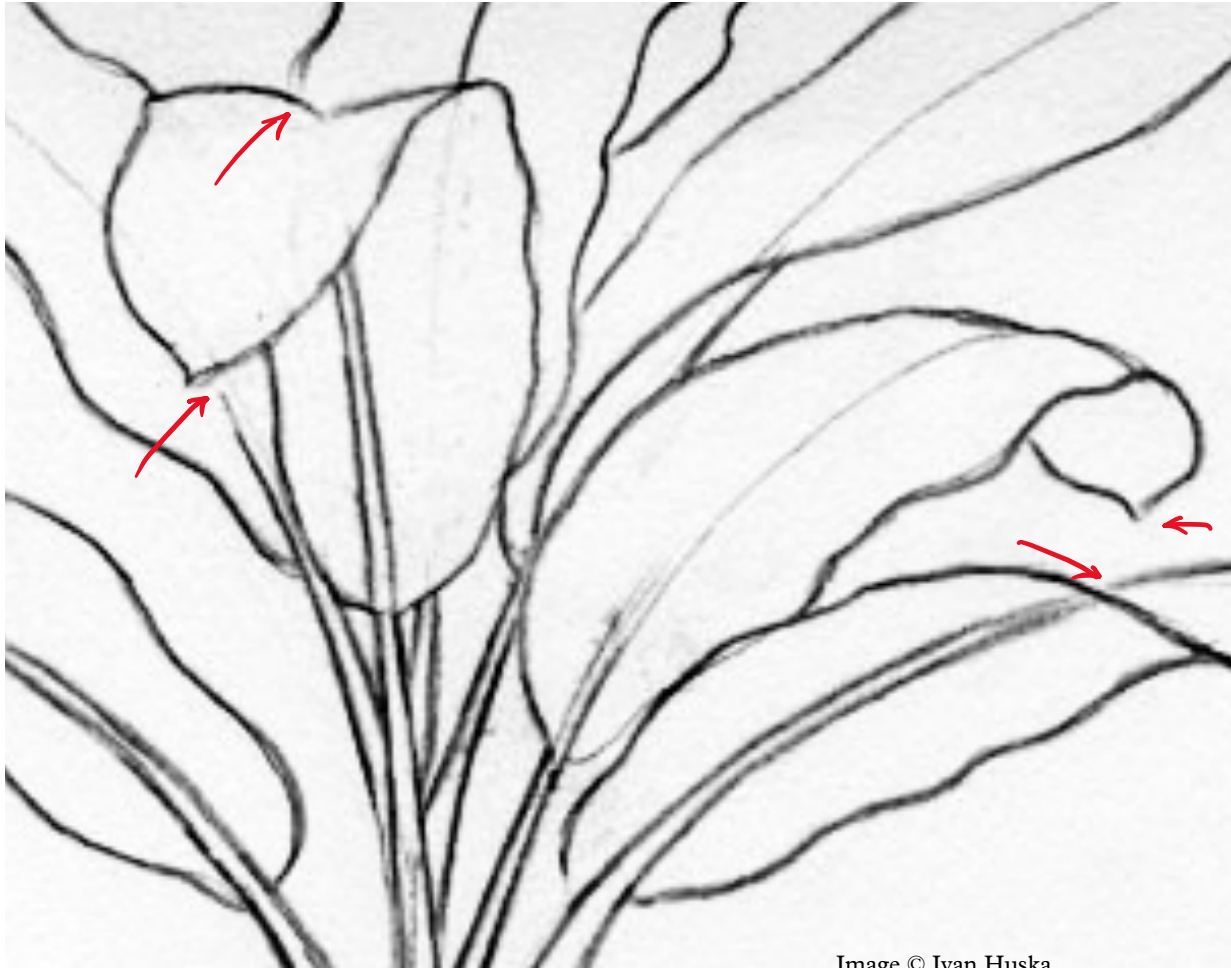
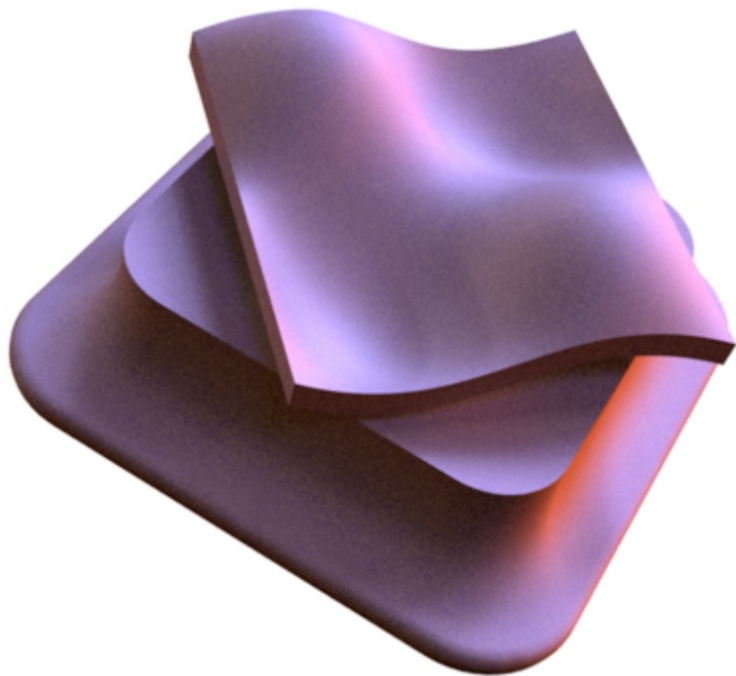

Image © Ivan Huska

# Junctions and intersections: real and intended



# Where people draw lines



Prompt

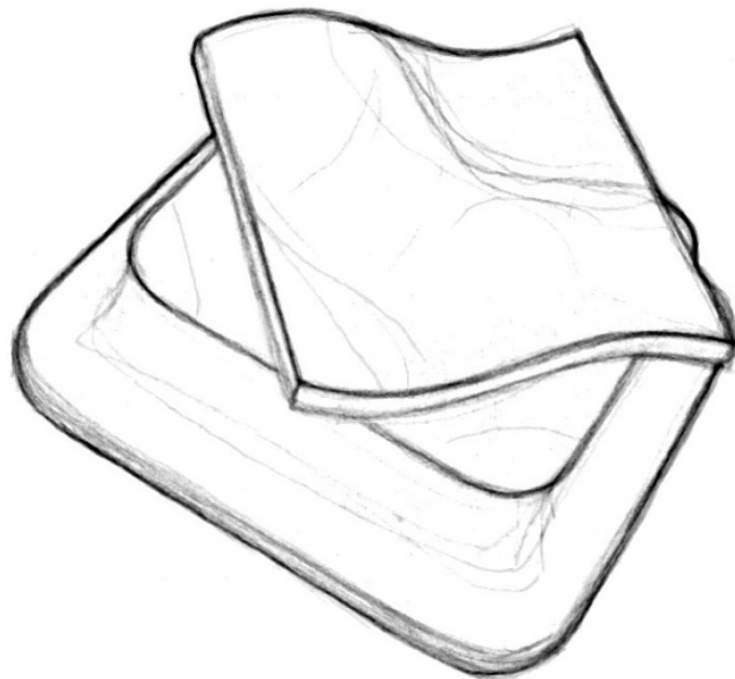

Many artists

# Where people draw lines: Occluding contours

points where surface normal is perpendicular to the view direction

$$n \cdot (p - o_{camera}) = 0$$

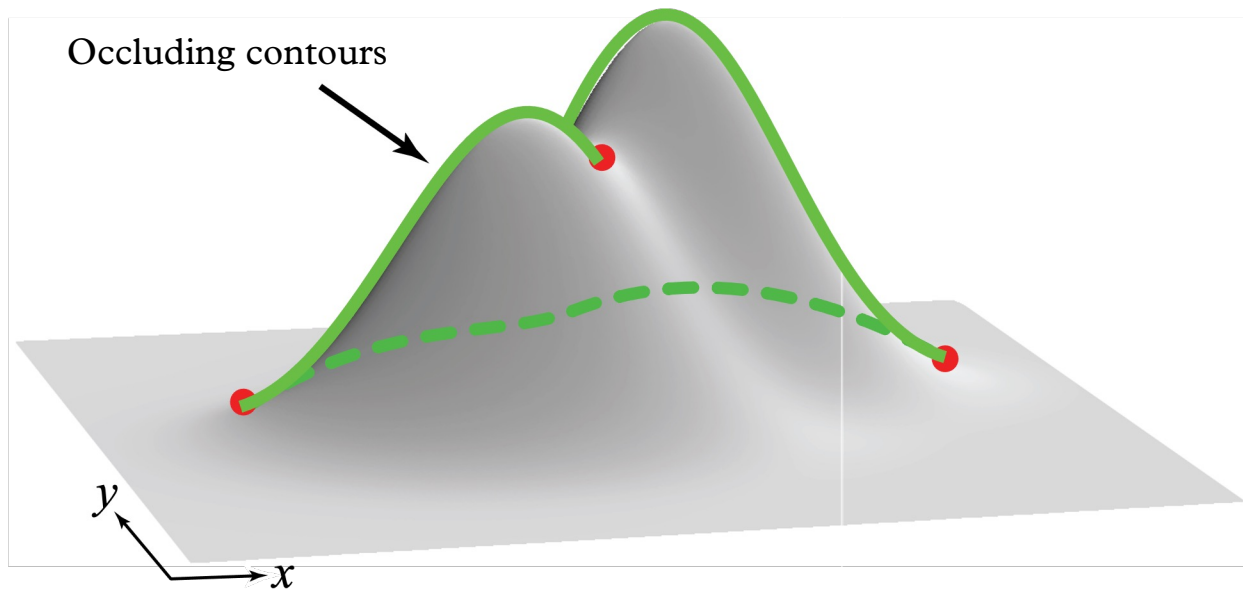

[Cole et al. 2008]

# Where people draw lines: Occluding contours

points where surface normal is perpendicular to the view direction

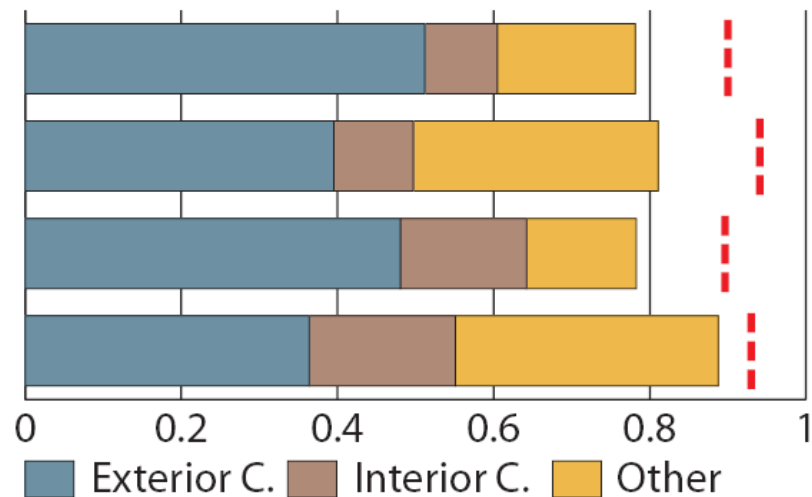
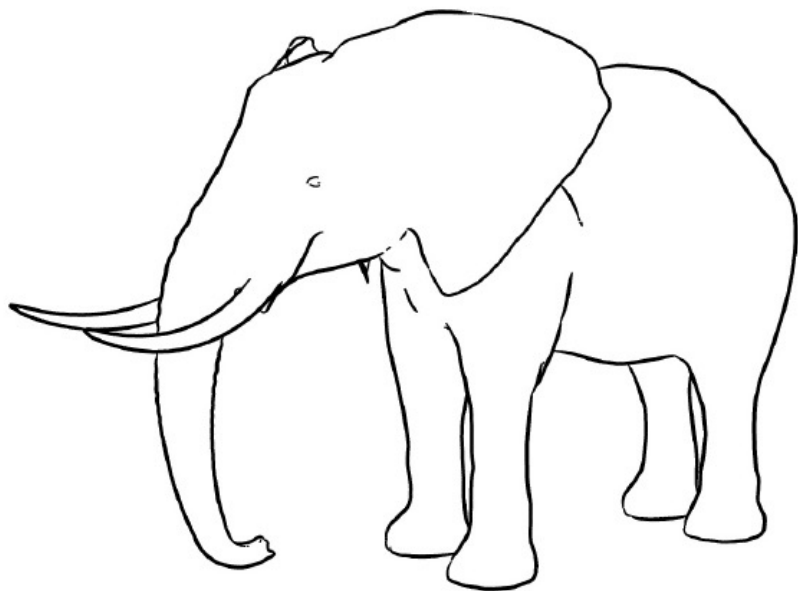

# Where people draw lines: **Ridges & Valleys (RV)** and Apparent RV

Extrema of principal curvature

$$\frac{\partial k_1}{\partial T_1} = 0$$

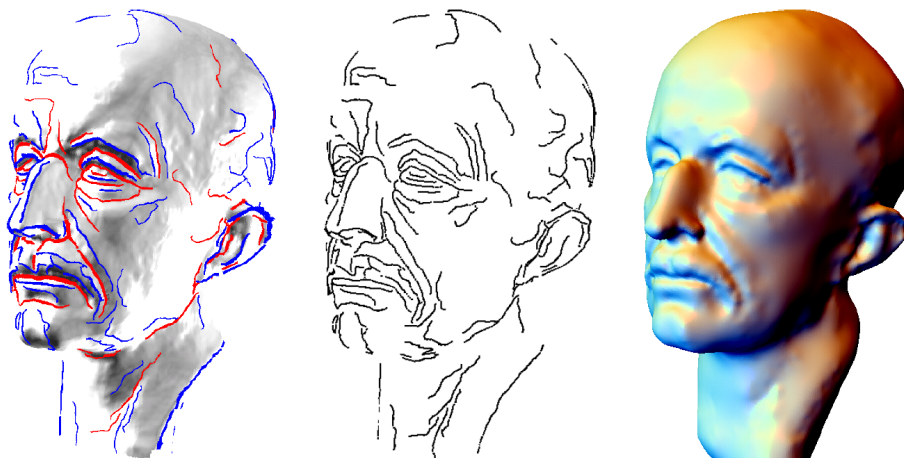

[Ohtake et al. 2004]

# Where people draw lines: Ridges & Valleys (RV) and Apparent RV

Extrema of view-dependent curvature

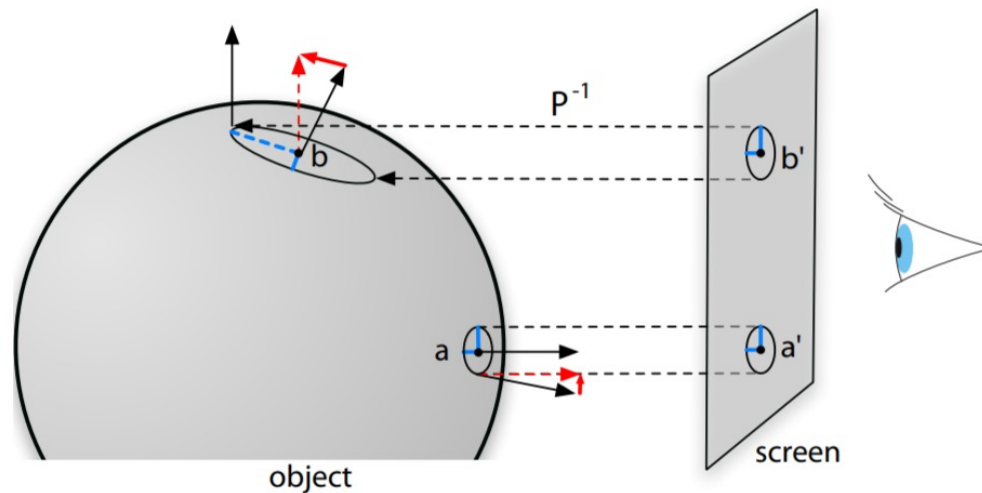
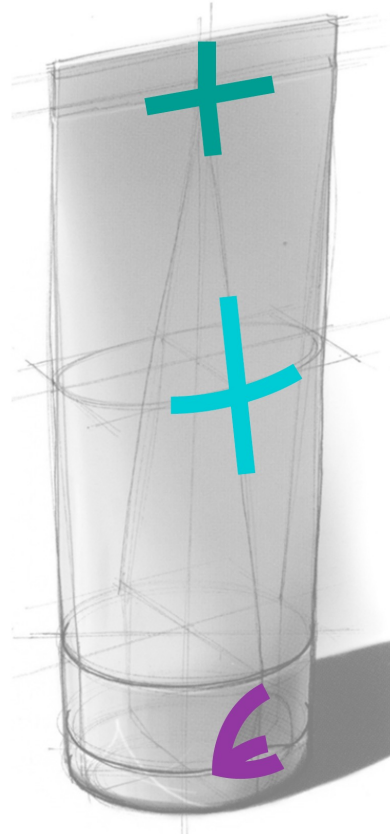

**Figure 4:** *The maximum view-dependent curvature at  $b'$  is much larger than at  $a'$  uniquely because of projection.*

[Judd et al. 2007]



## 2D cross-sections: lines of curvature



# Can we just use synthetic sketches then? No.

”60% of drawn content is consistent with computer-generated output”



Synthetic

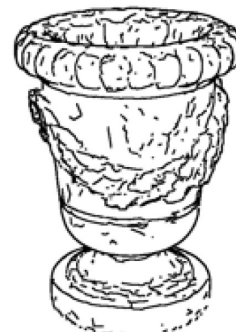
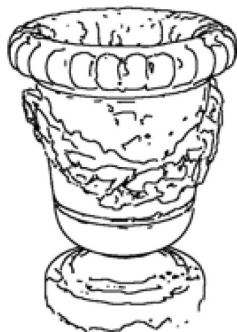

Real



# Checkpoint

Sketches have many different stroke types, drawn for very different purposes. Those connect at junctions and intersections. They also have fills and textures

Sometimes determining who's who is difficult.

the shapes sketches represent

# 2D shape

Strokes only: non-manifold

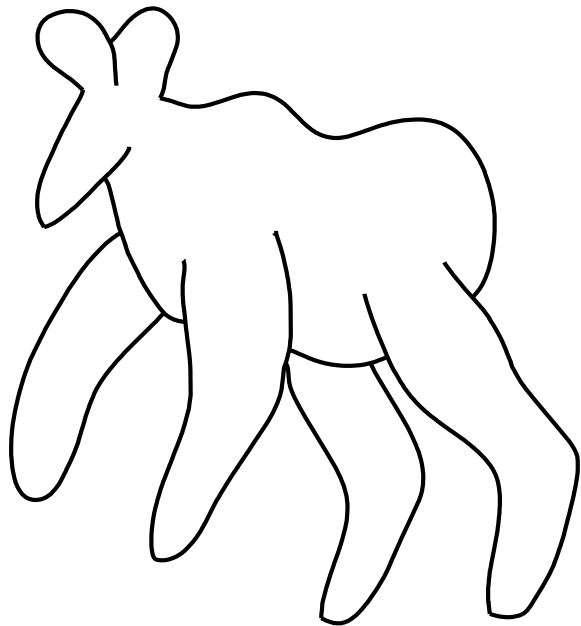

With fills and thickness: 2-manifold

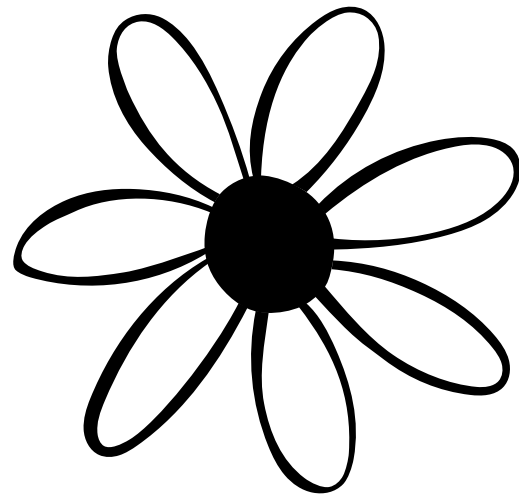
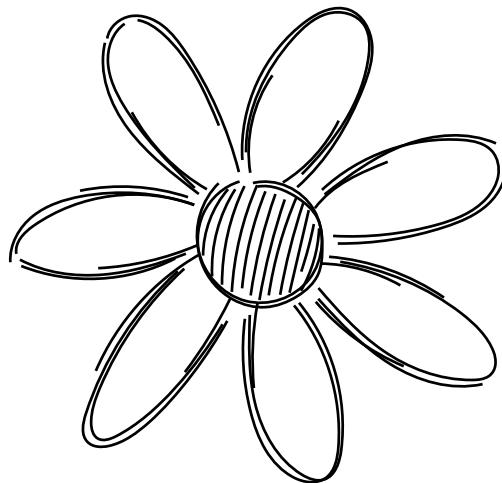

[Myronova et al. 2023]

Clusters = approximate curve or variable width

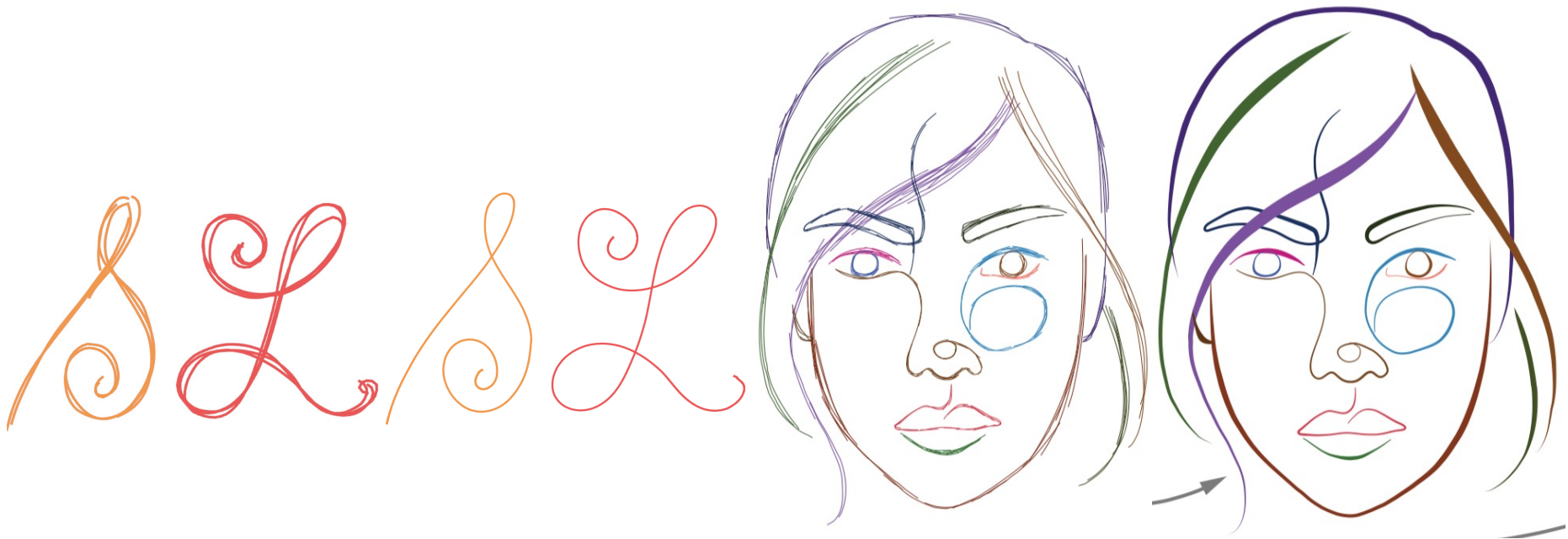

[van Mossel et al. 2021]

# Implied junctions and continuations

Gestalt continuity, symmetry, perception stuff

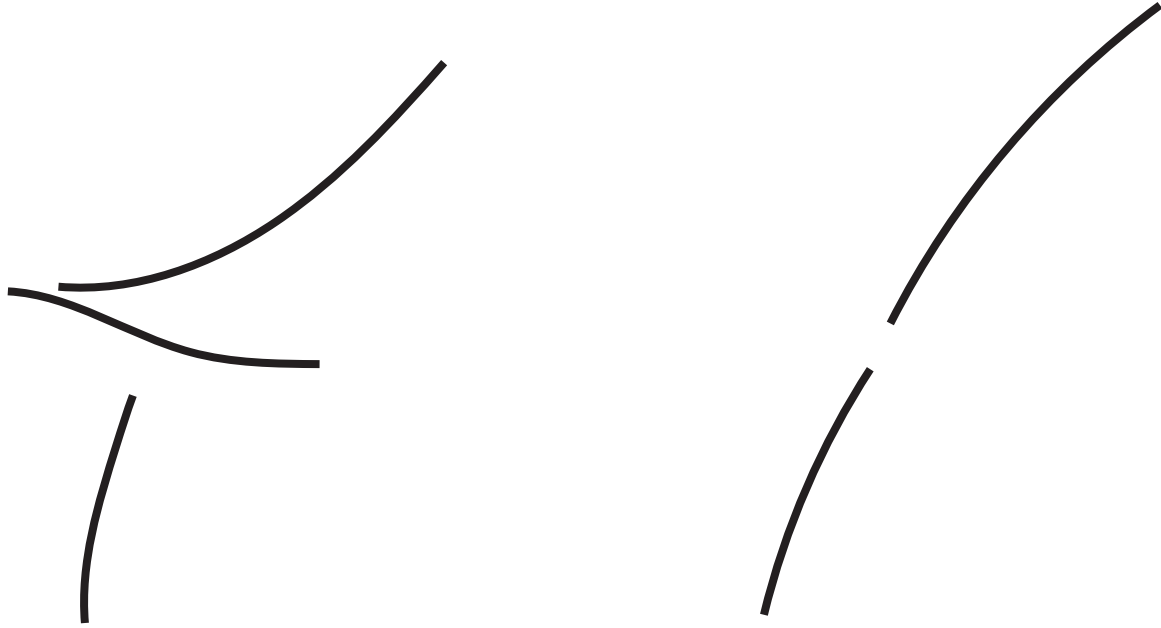

# Implied junctions and continuations

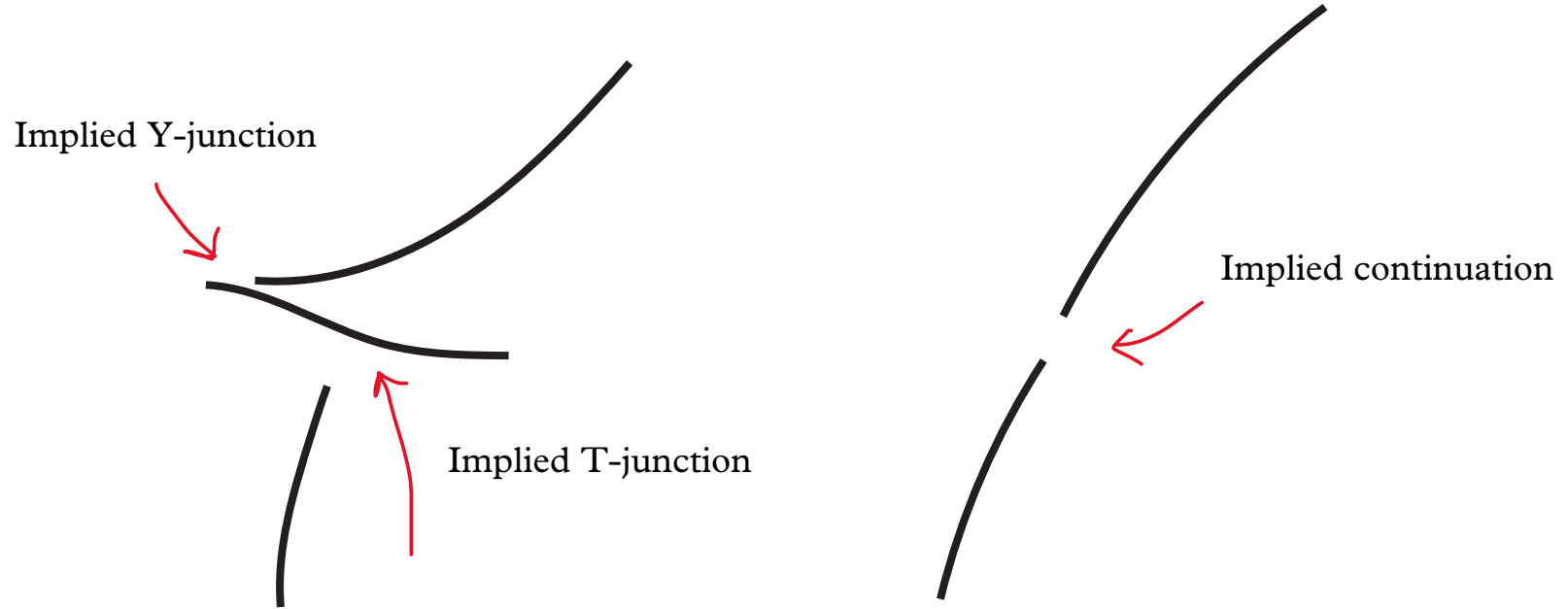



# Implied junctions and continuations

Gestalt (Good) Continuation

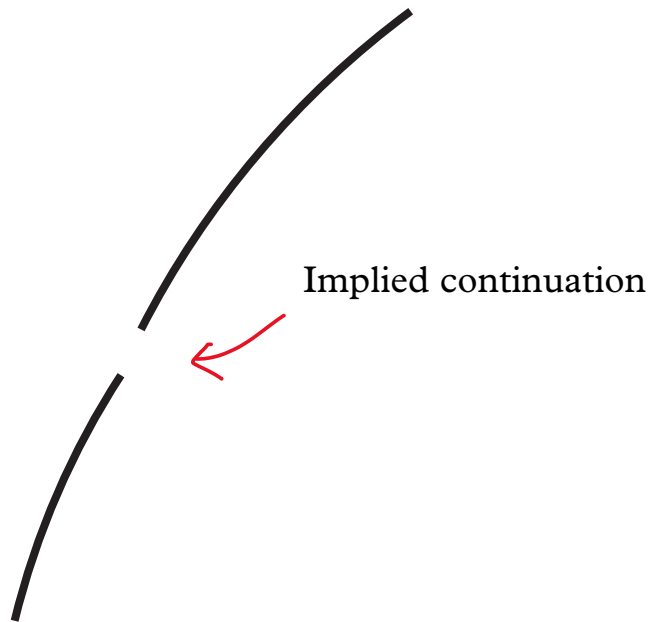

[Koffka 1955]

90% participants see paths if angle  $< 18^\circ$

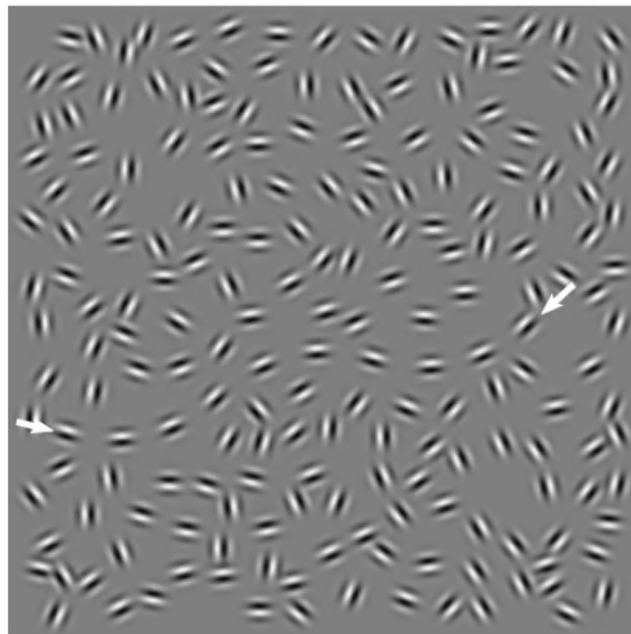

[Hess and Field 1999]

# Holes or not? Inside vs outside

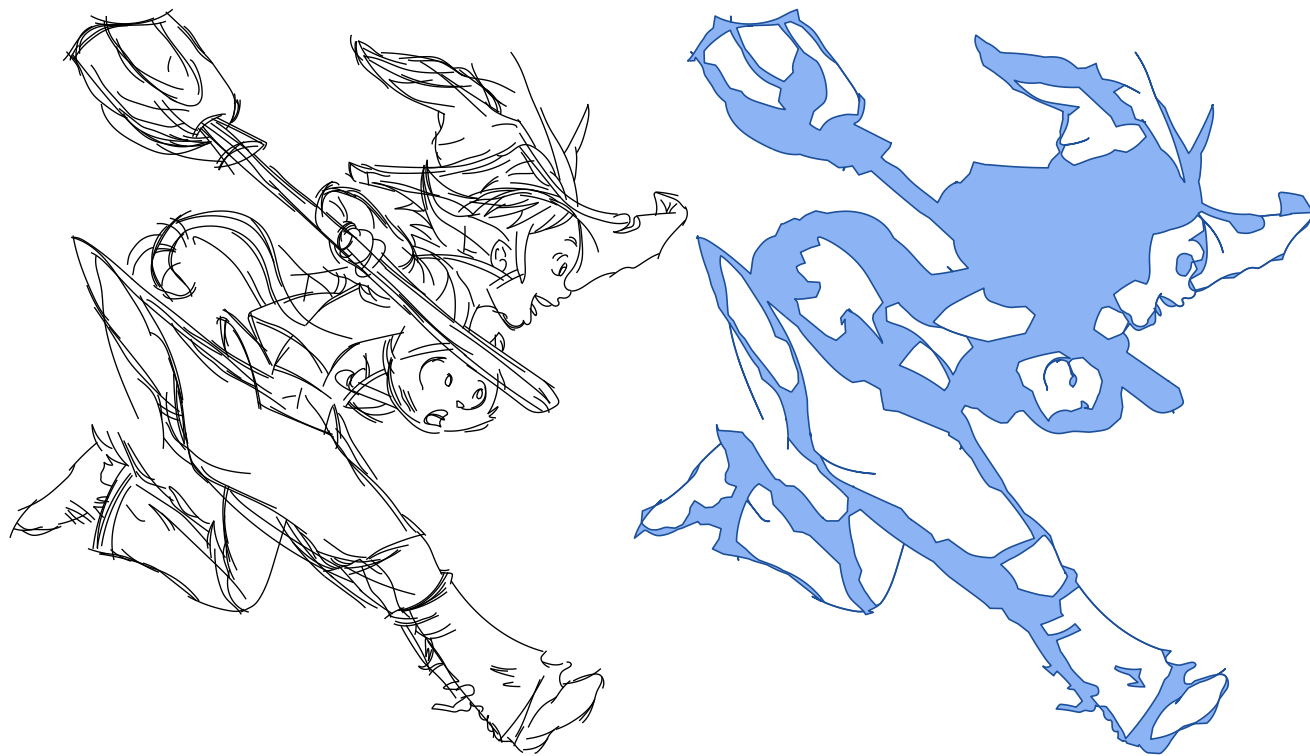

[Myronova et al. 2023]

# Junctions and occlusions

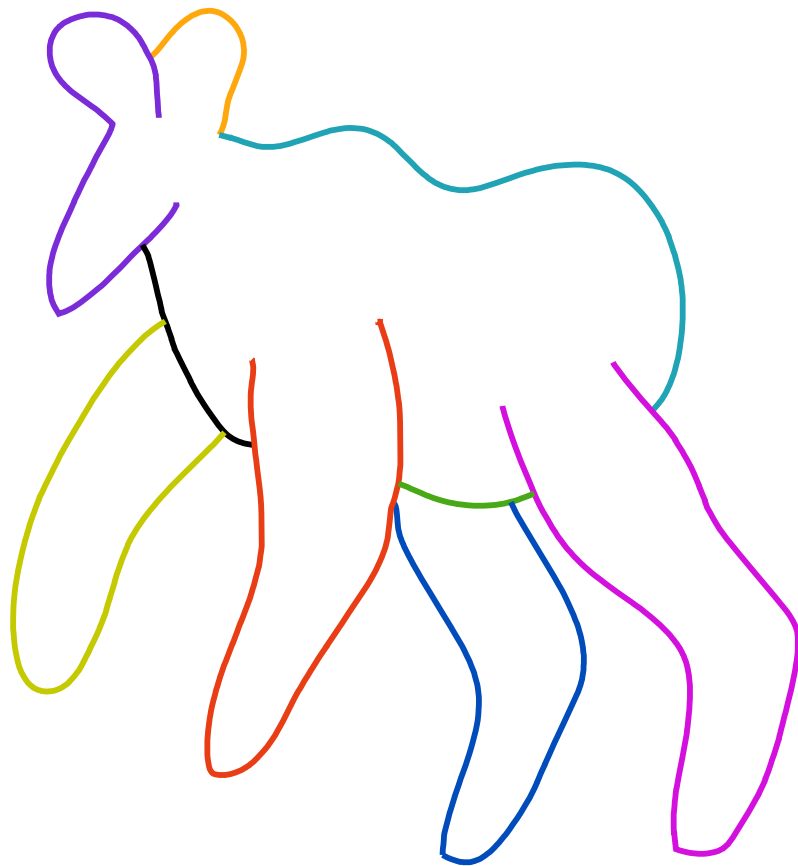

3D: smooth unless indicated otherwise

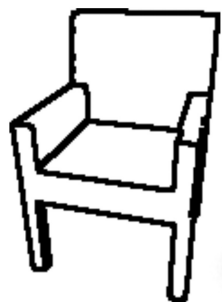

[Zheng et al. 2023]

3D: smooth unless indicated otherwise

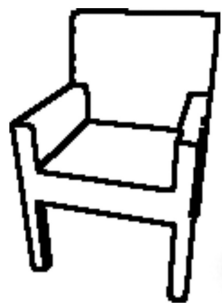

Ground truth  
[Zheng et al. 2023]

3D: **smooth** unless indicated otherwise

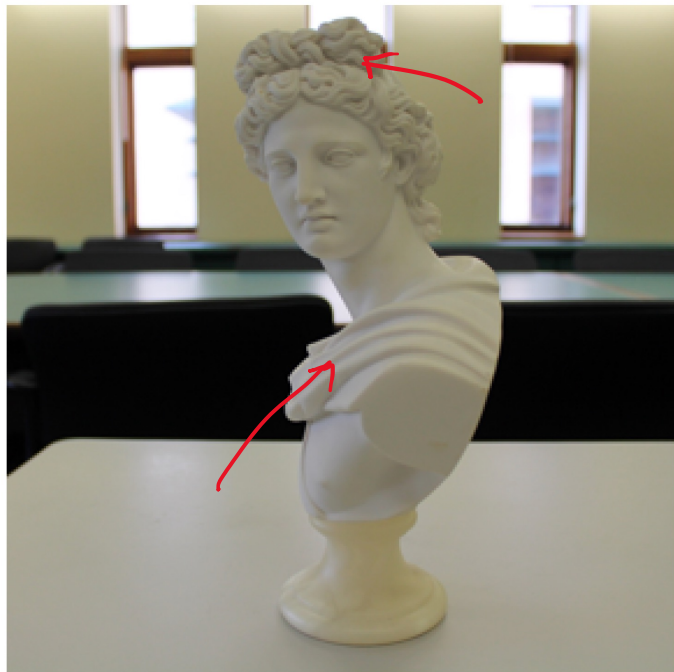

[Wang et al. 2021]

core challenges of sketches  
and some solutions

# core challenges of sketches and some solutions

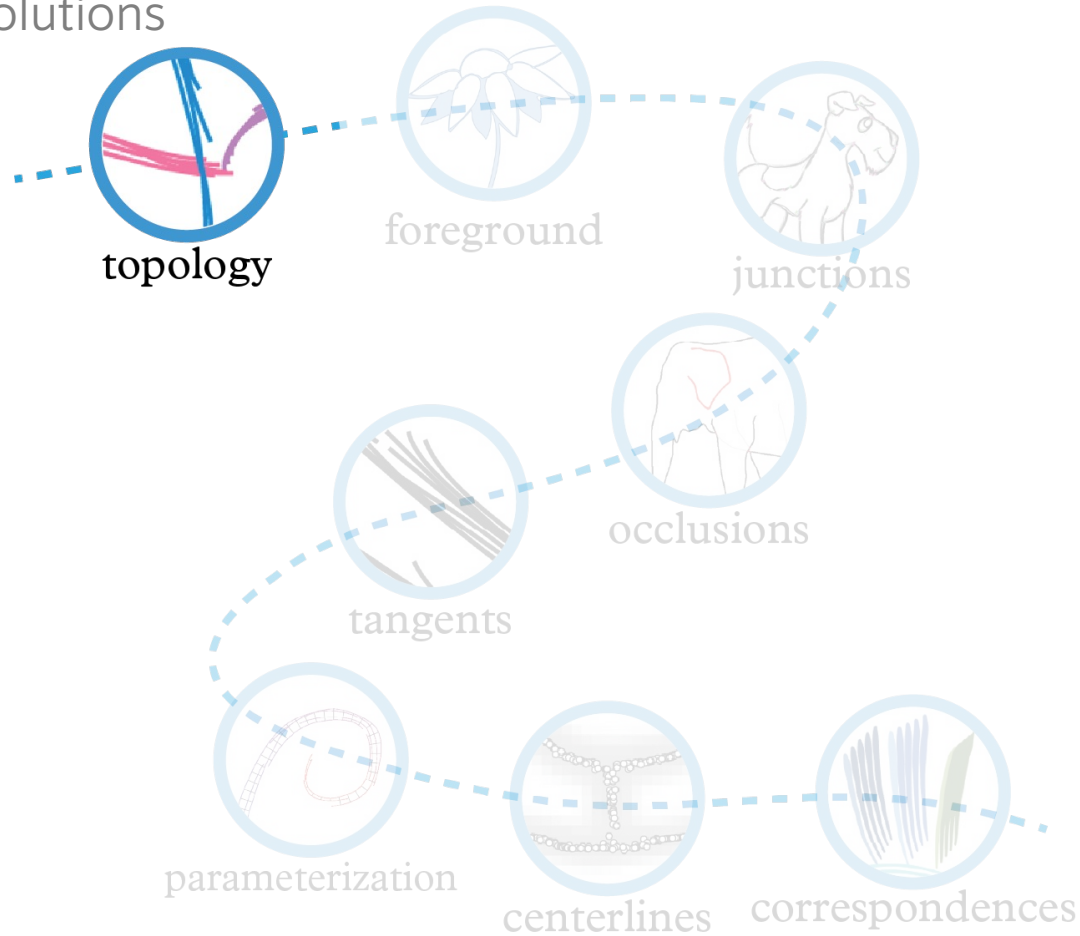



## Core challenge: Topology

Are those strokes connected?

Is it a junction?

Is this shape closed?

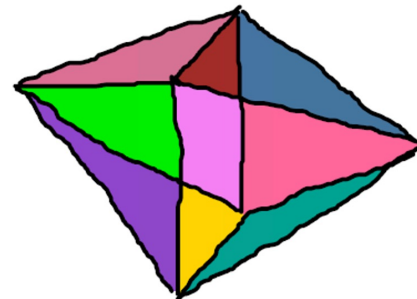
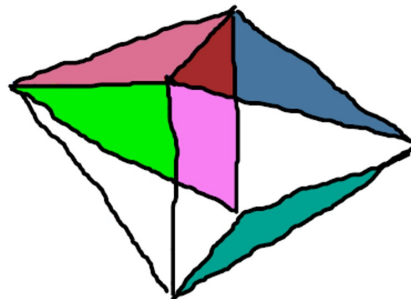
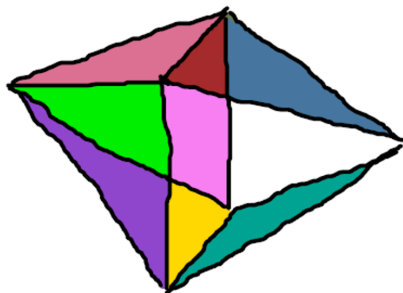
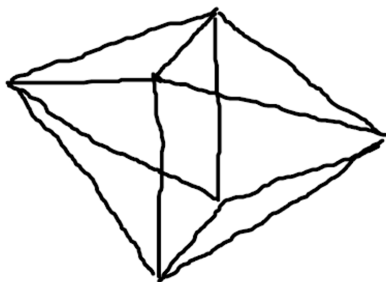

[Yin et al. 2022]

## Core challenge: Topology

Are those strokes connected?

Is it a junction?

Is this shape closed?

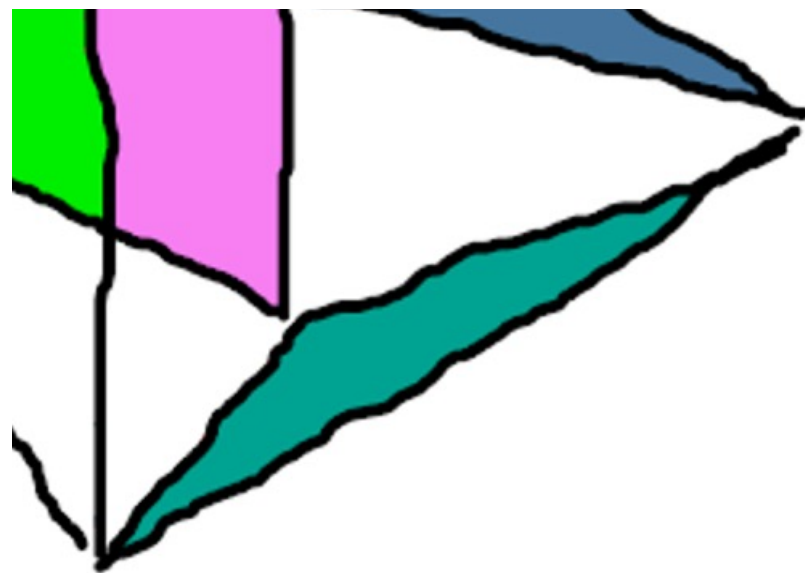
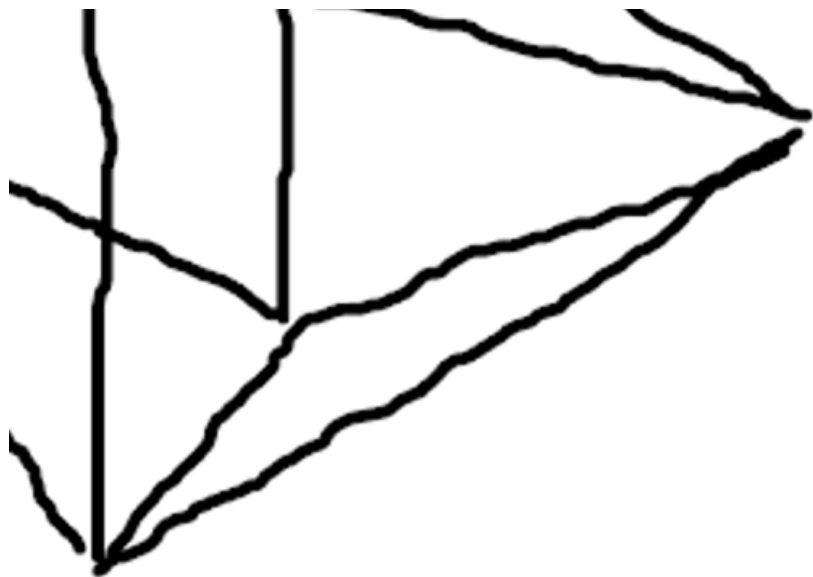

# Core challenge: Topology

Bug or feature?

Precision can vary over a single drawing

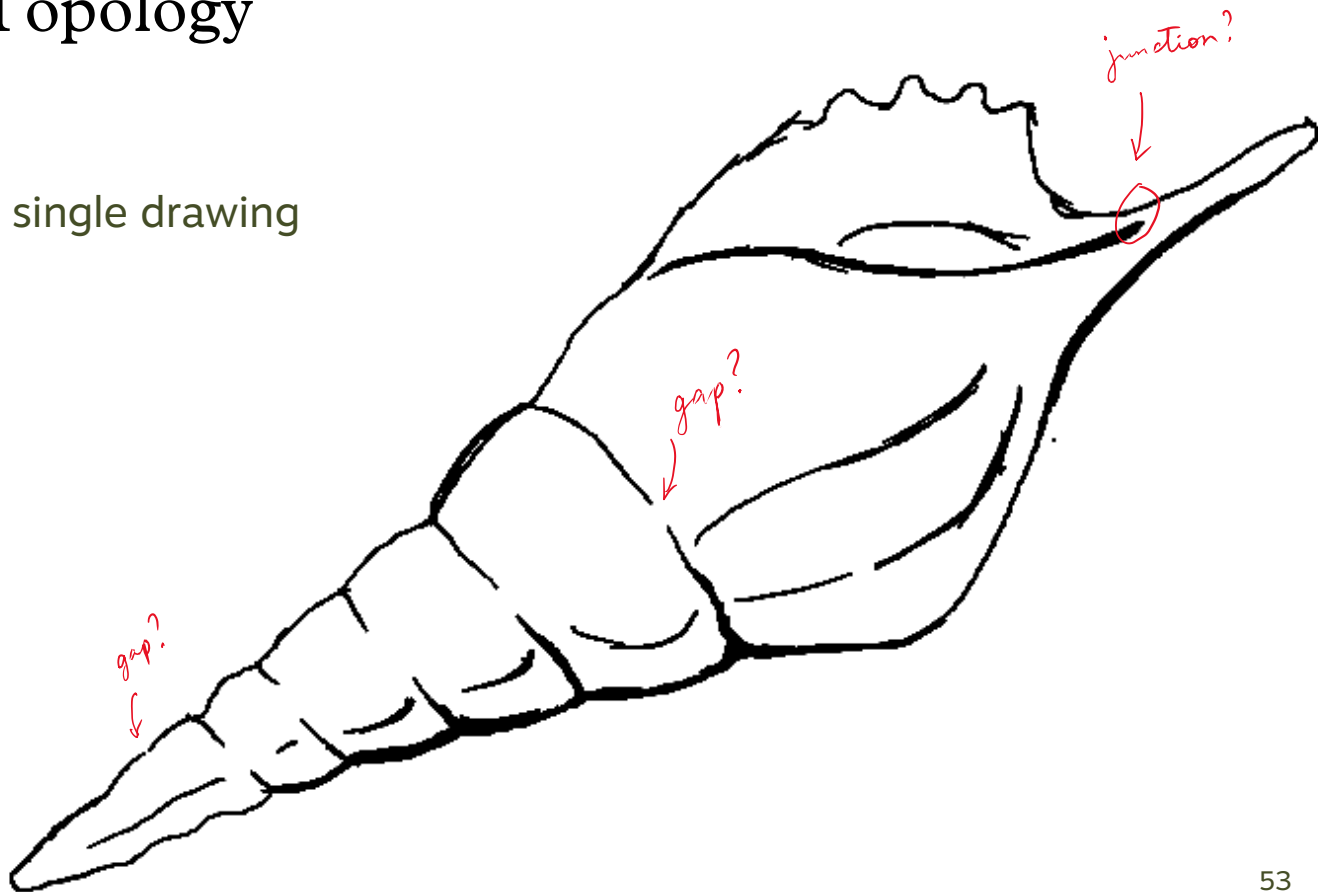

# Core challenge: Topology

Bug or feature?

Precision can vary over a single drawing

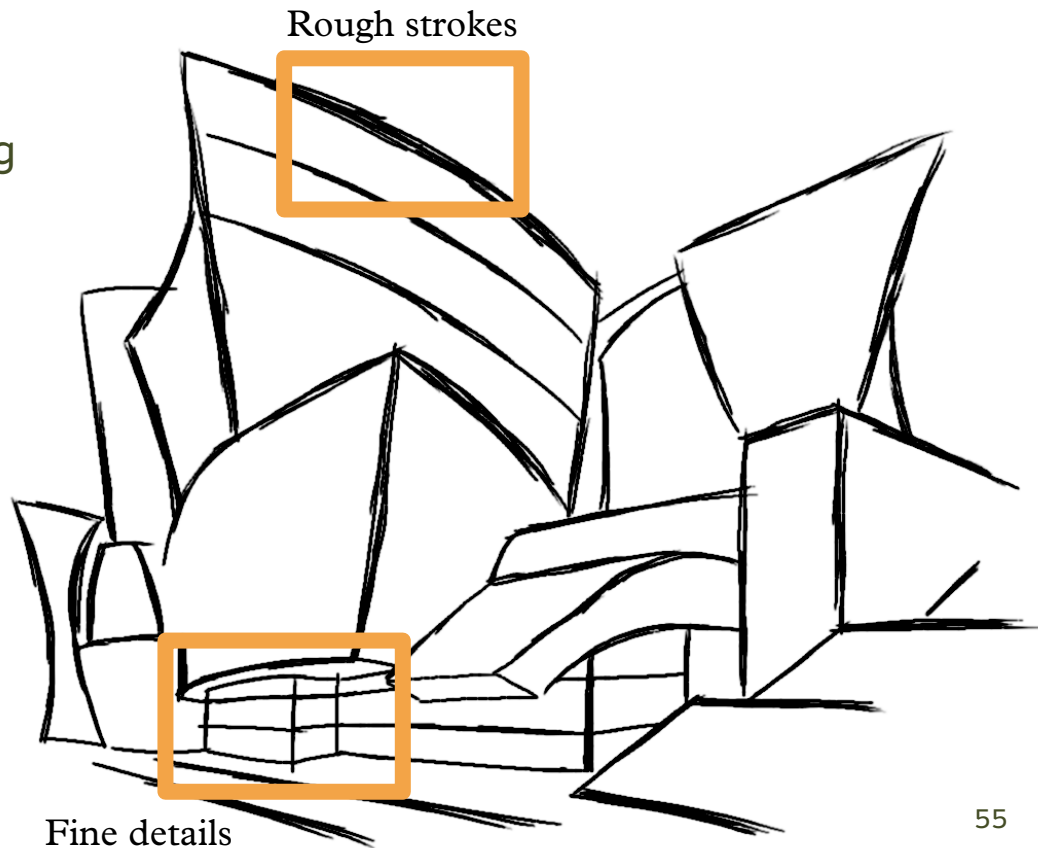

## Core challenge: Topology

How to segment, or break into clusters?

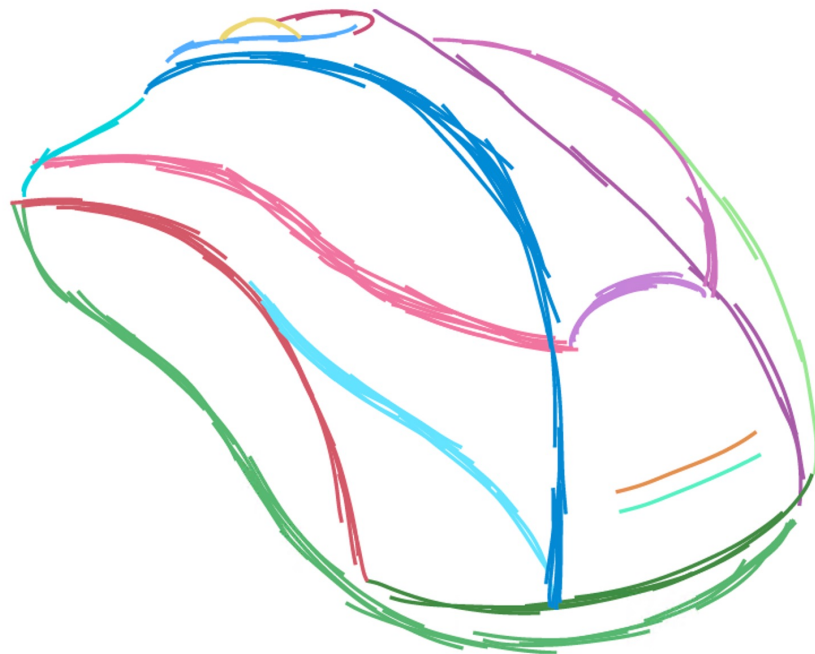
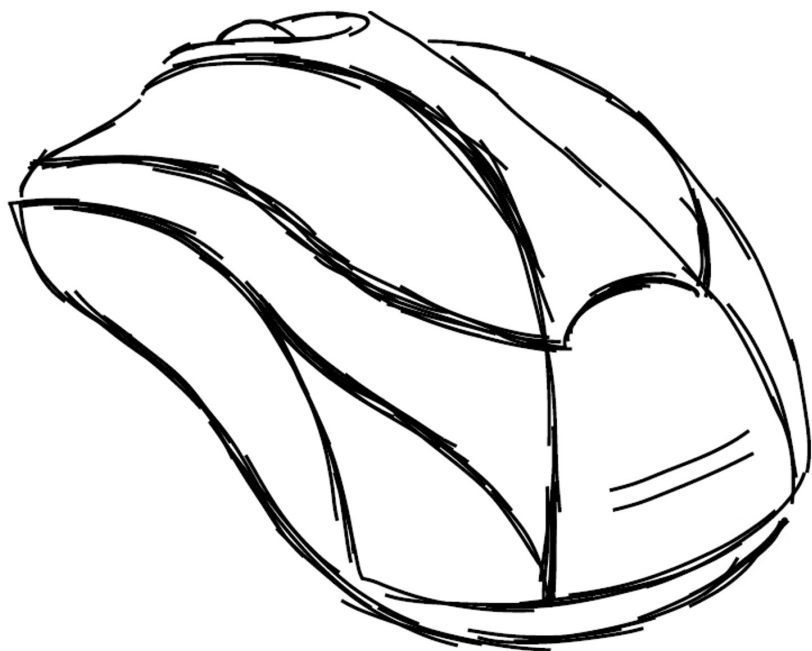

# Topology | Solution: Learning

Hand-crafted features

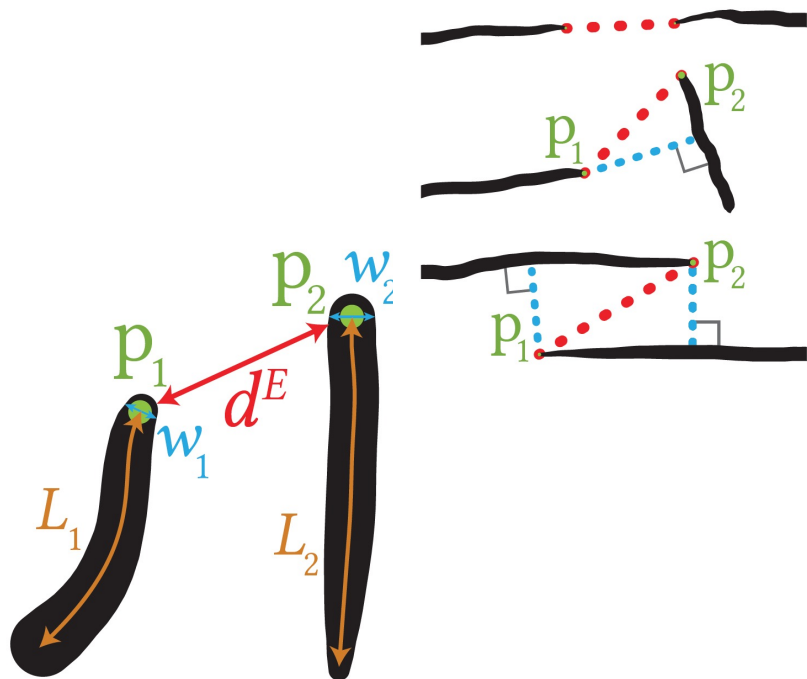

Classification via **Random Forest**

Random Sampling with Replacement

$$\mathcal{X} \in \mathbb{R}^{250 \times 100}$$

$$\mathcal{X}_1 \in \mathbb{R}^{60 \times 100}$$

$$\mathcal{X}_2 \in \mathbb{R}^{60 \times 100}$$

$$\mathcal{X}_n \in \mathbb{R}^{60 \times 100}$$

Train

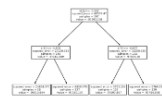
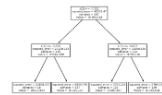

Aggregate

# Topology | Solution (?): Reeb Graph

Take some function  $f$  on a manifold

Draw all its level sets  $f^{-1}(c)$

Contract their connected components

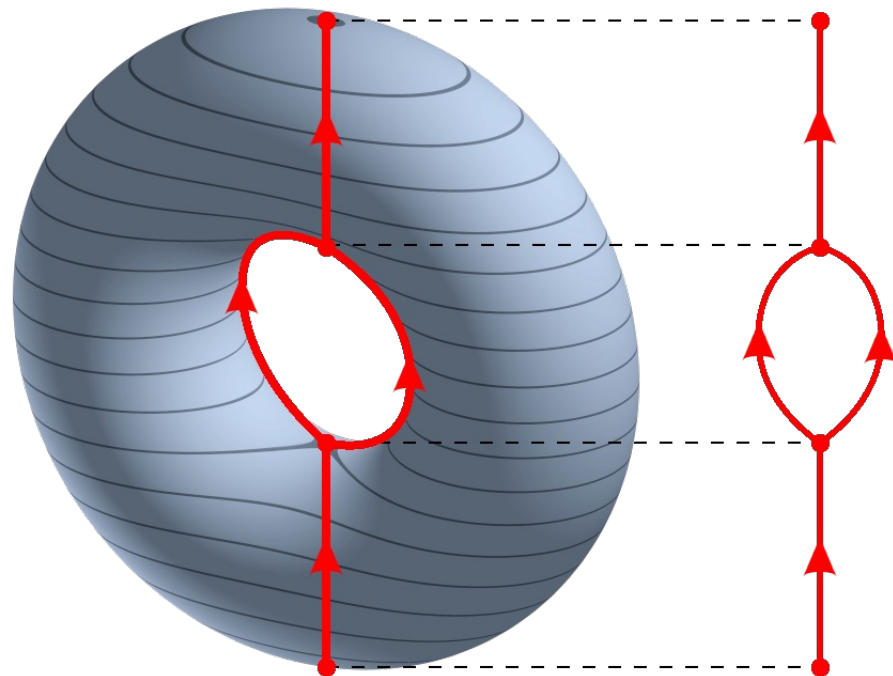

# Topology | Solution (?): Reeb Graph

Take some function  $f$  on a manifold

Draw all its level sets  $f^{-1}(c)$

Contract their connected components

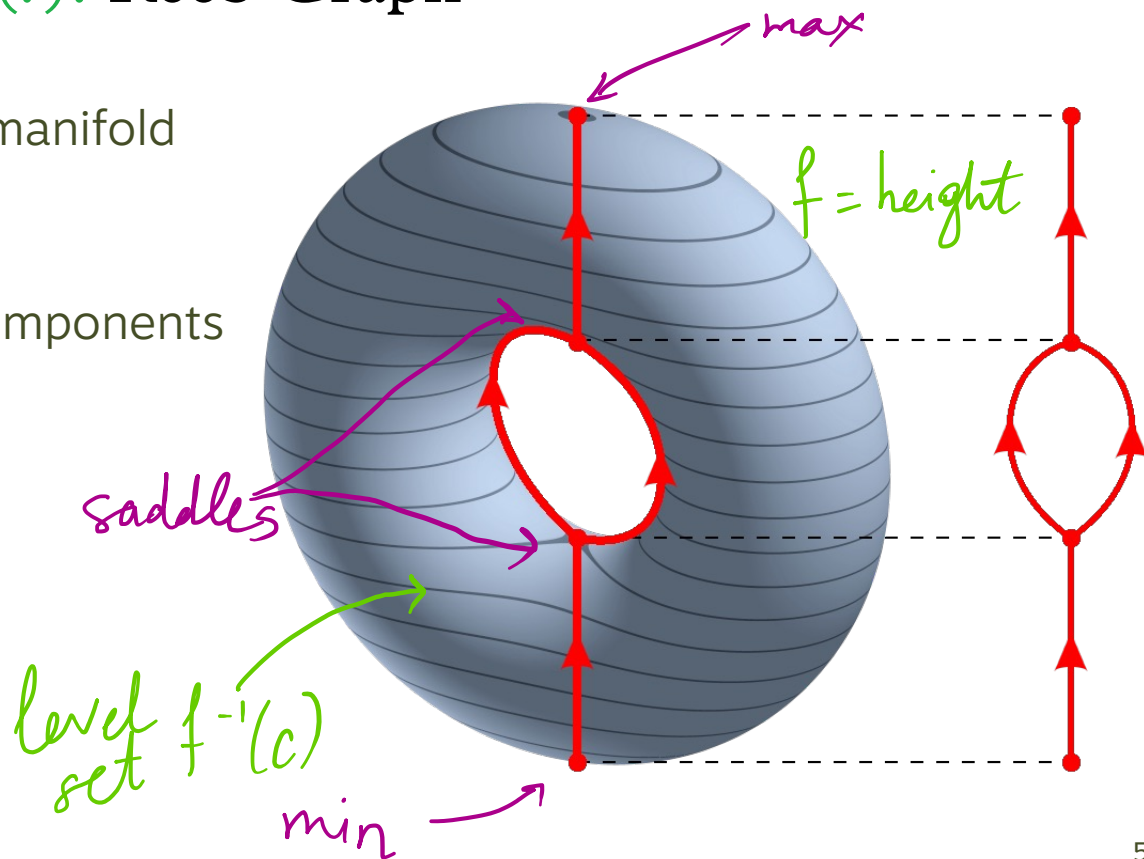



# Topology | Solution (?): Reeb Graph

Stroke cluster -> Reeb graph

Function = cluster parameterization

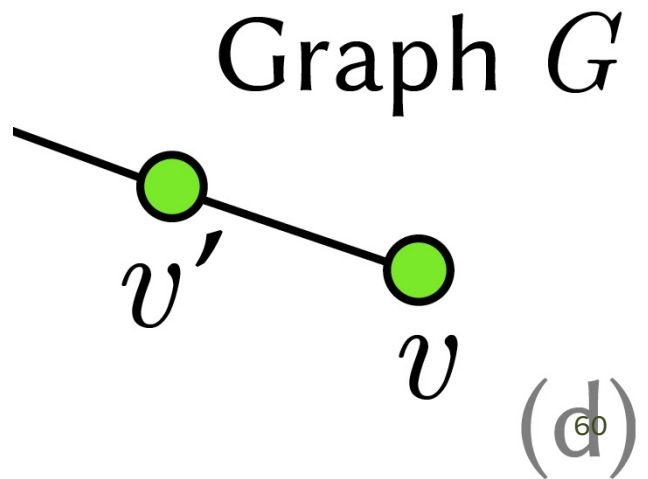
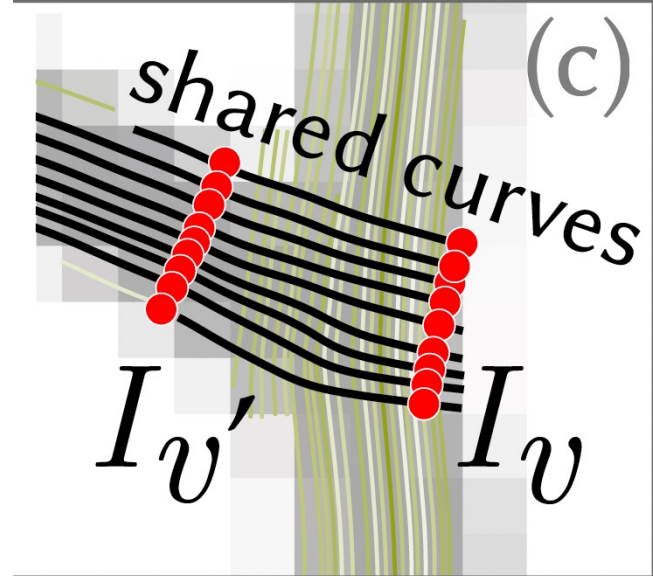

# core challenges of sketches and some solutions

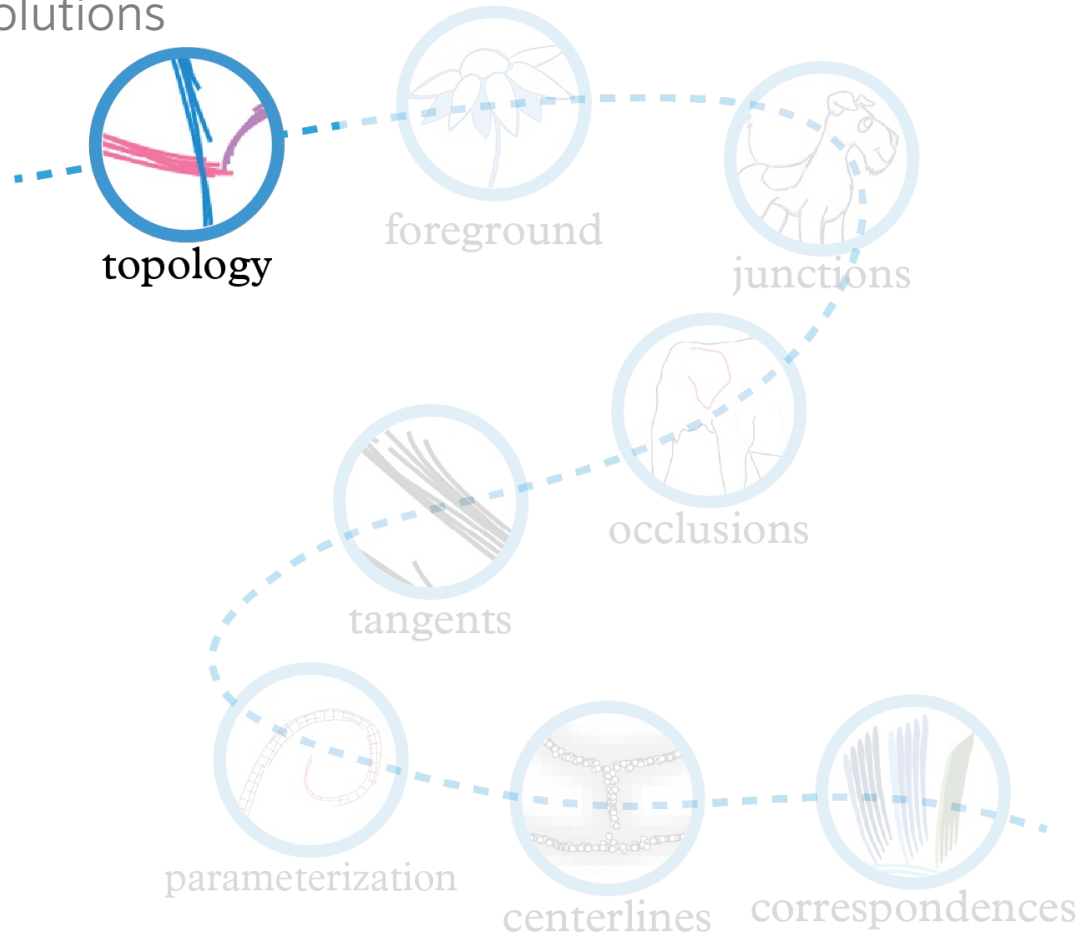

# core challenges of sketches and some solutions

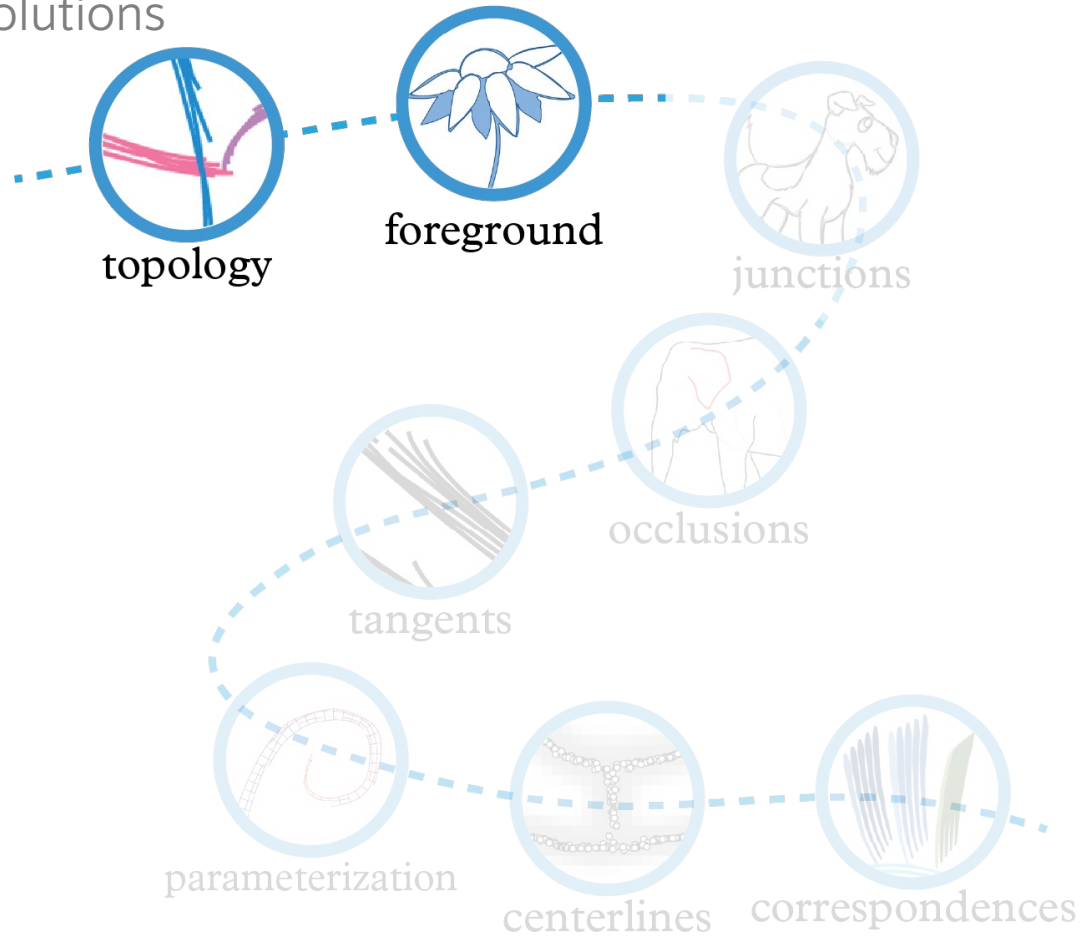

# Core challenge: Background vs foreground



Image © Zoska Leutina

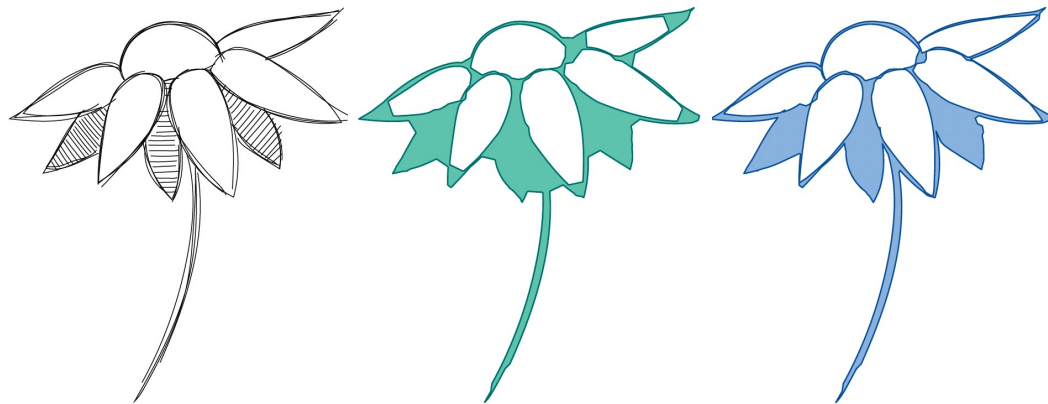

[Myronova et al. 2023]

# Background vs Foreground | **Solution:** Čech complex

Input: points  $\in \mathbb{R}^2$  or  $\mathbb{R}^3, \varepsilon > 0$

Draw an  $\varepsilon$ -ball around every point

Create a simplex whenever  $\varepsilon$ -ball intersect

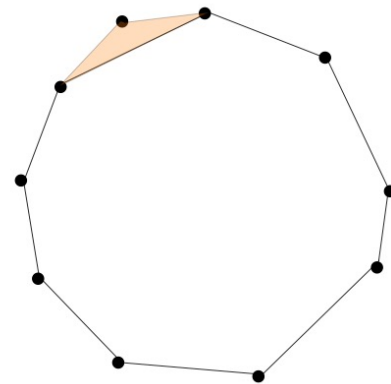
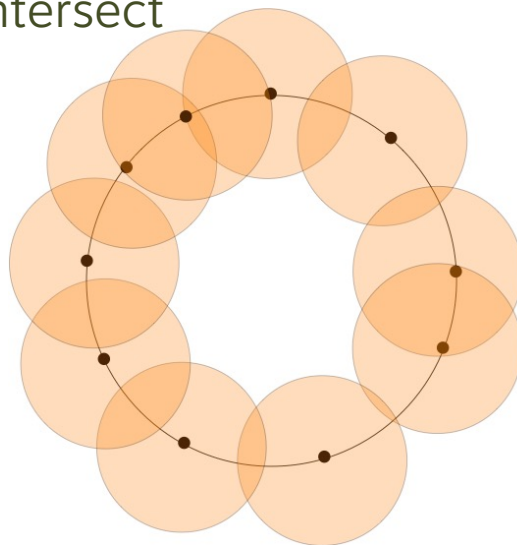

# Background vs Foreground | **Solution:** Sketch complex

Connect **some** stroke vertices within an  $\varepsilon$ -radius

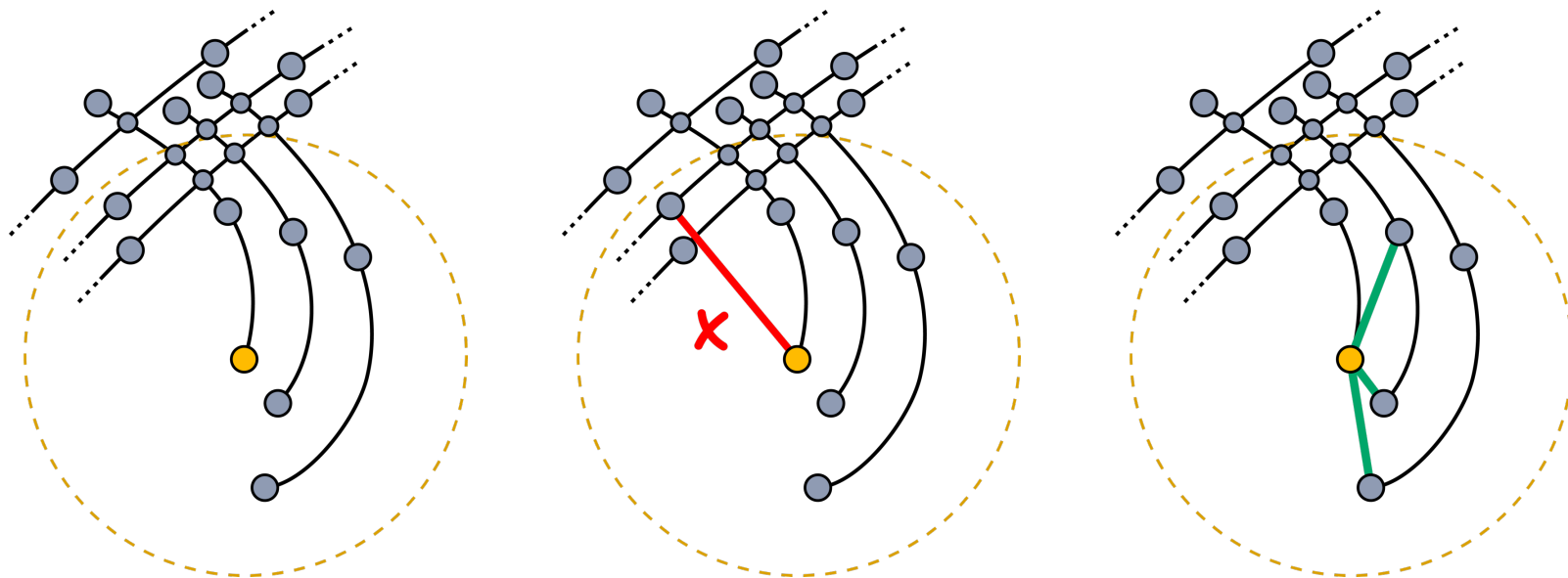

# Background vs Foreground | **Solution:** Sketch complex

Connect **some** stroke vertices within an  $\varepsilon$ -radius

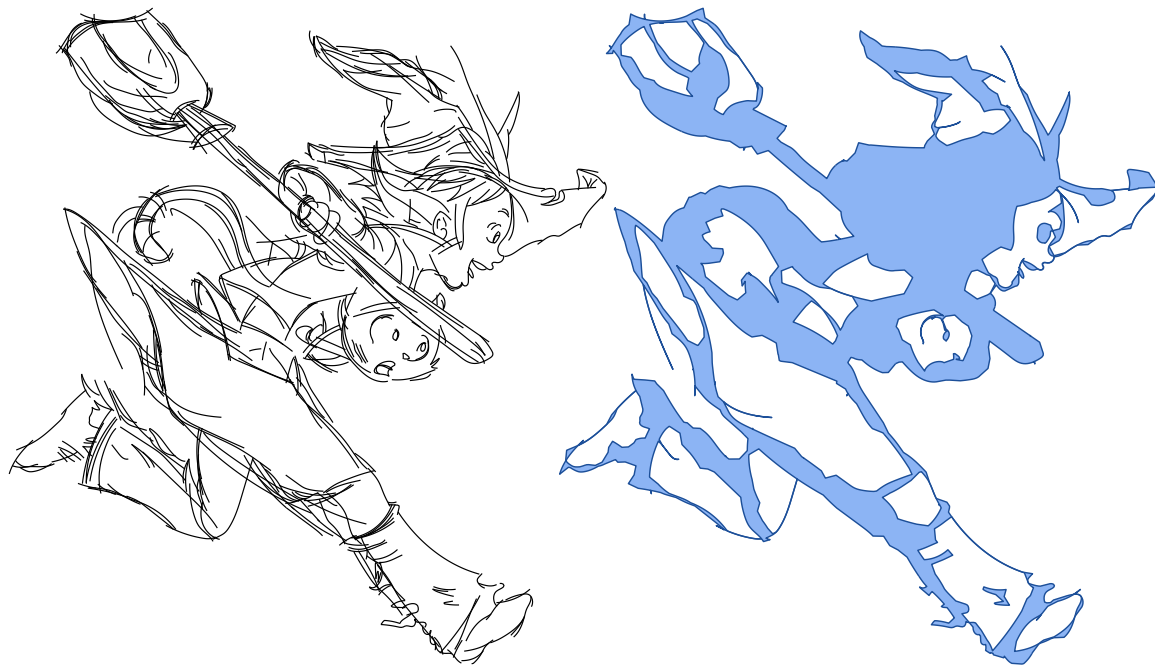

# Background vs Foreground | **Solution:** Sketch complex

Connect **some** stroke vertices within an  $\varepsilon$ -radius





# core challenges of sketches and some solutions

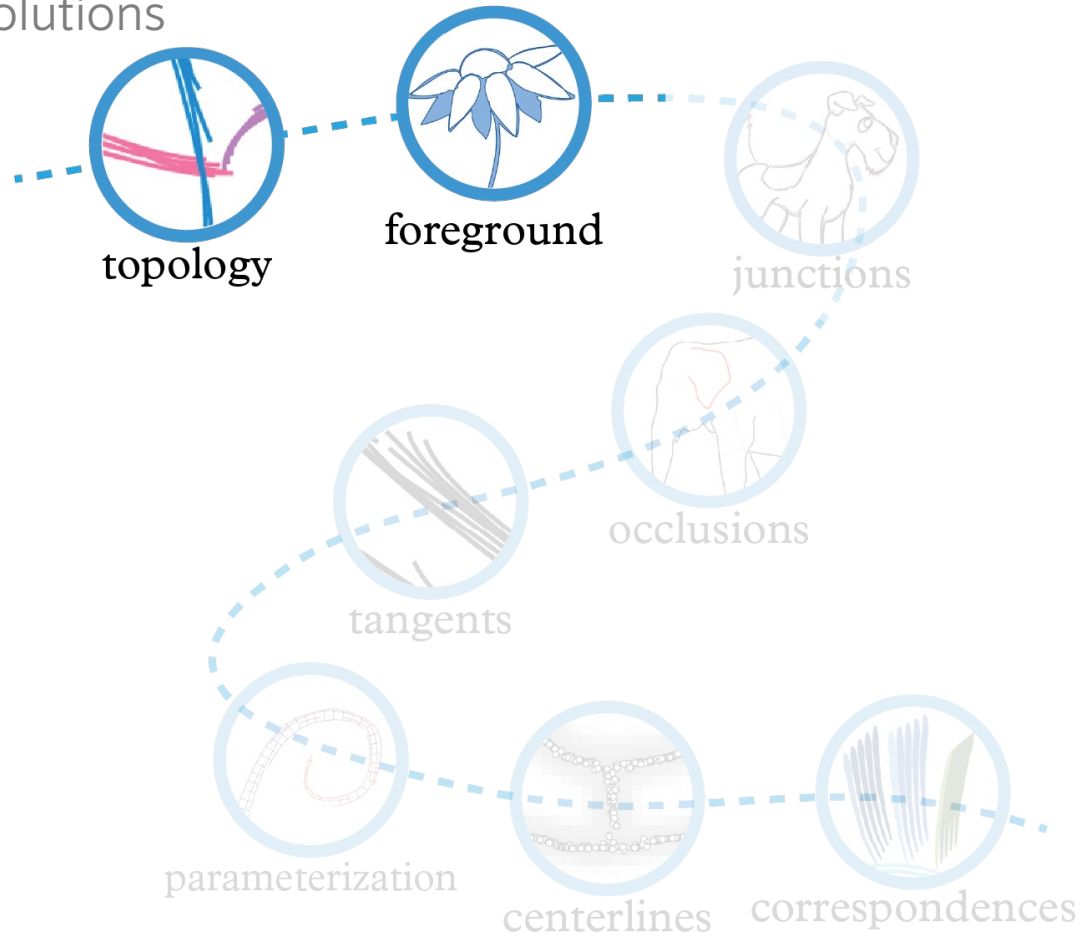

# core challenges of sketches and some solutions

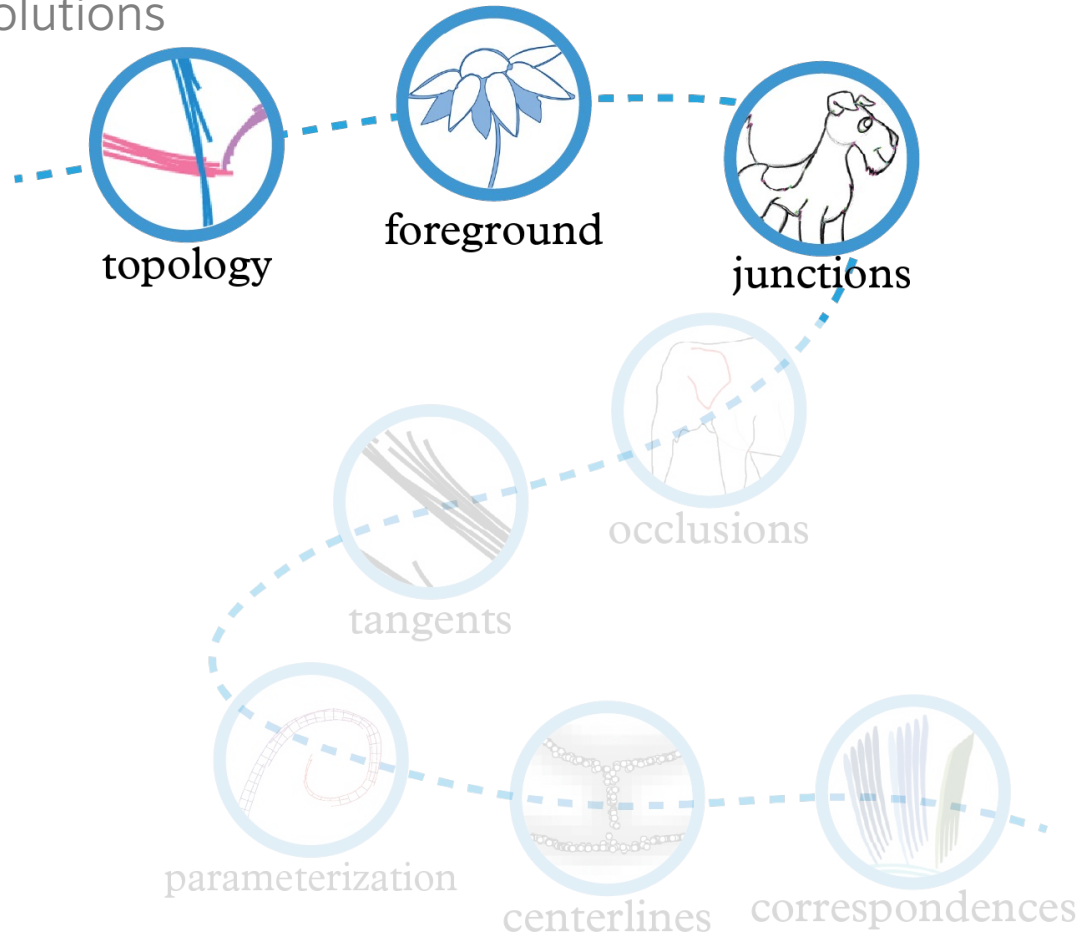

**Core challenge:** Where are endpoints, junctions, and intersections?



# Where are endpoints, junctions, and intersections | Solution

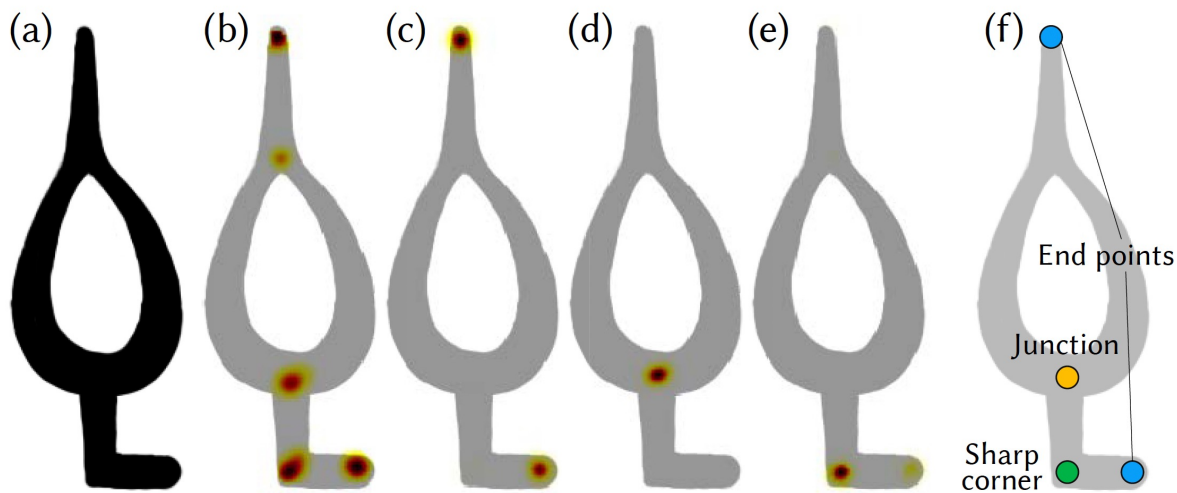
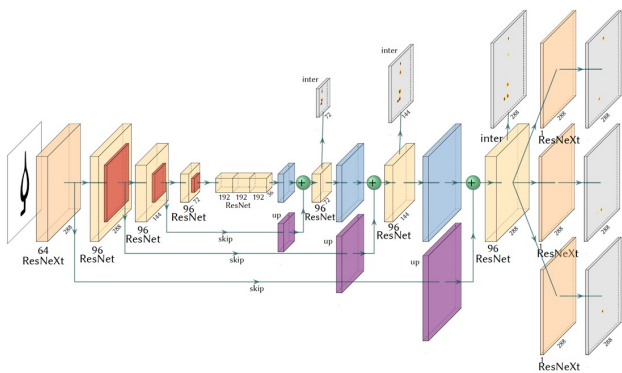

[Puhachov et al. 2021], [Yan et al. 2024]

**Core challenge:** Where are endpoints, junctions, and intersections?

What is the level of abstraction we want?



# core challenges of sketches and some solutions

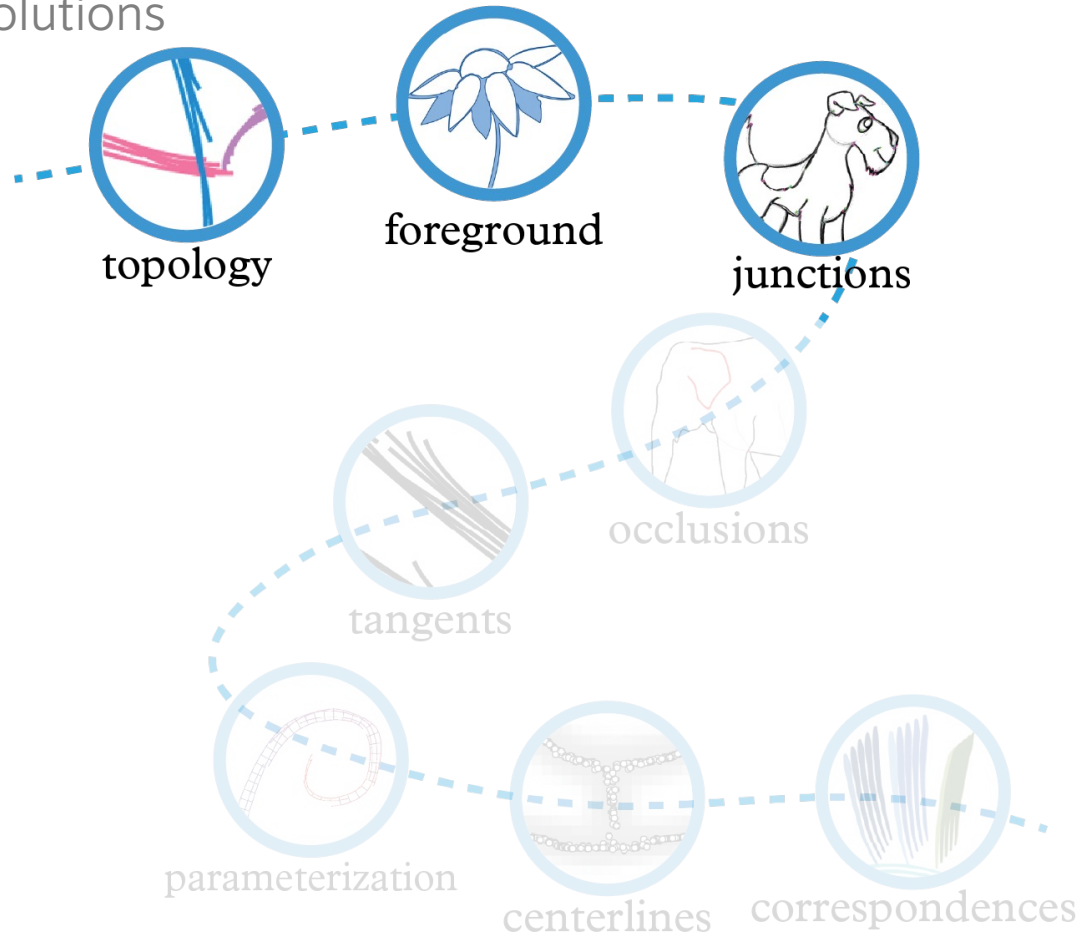

# core challenges of sketches and some solutions

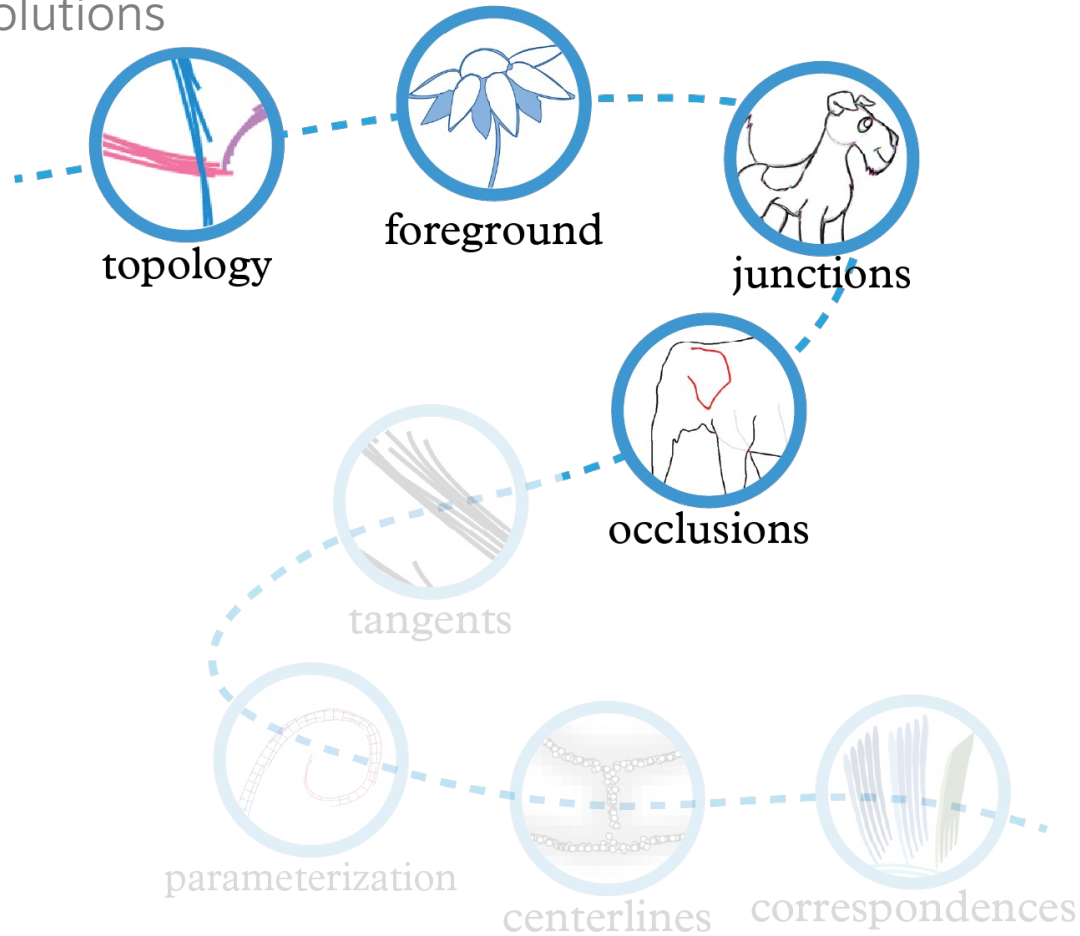

## Core challenge: Hidden contours

Draw manually

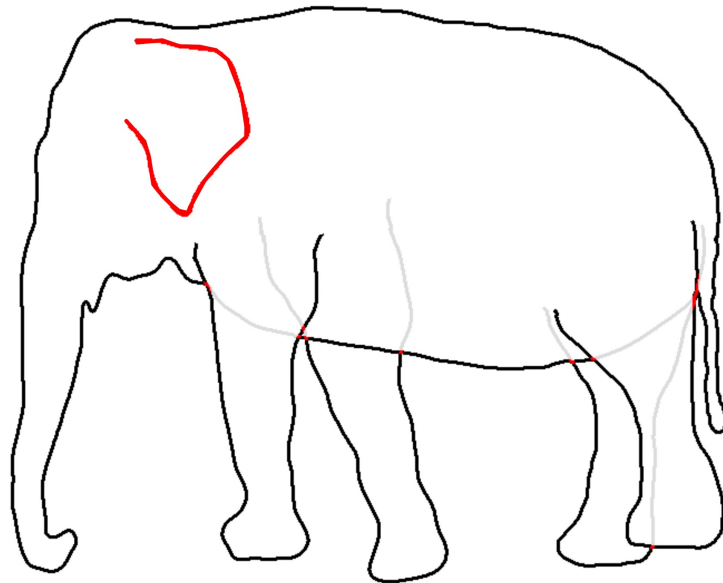

[Dvorožňák et al. 2018]



## Core challenge: Hidden contours

We are not good at imagining the shape of hidden contours

Connect endpoints heuristically with splines?

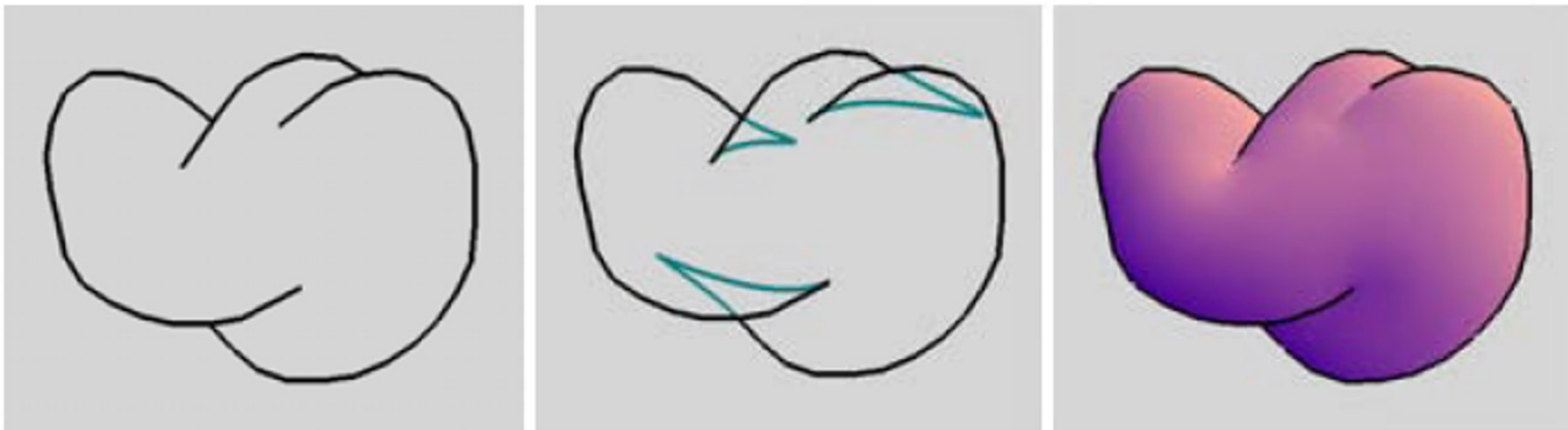

[Karpenko and Hughes 2006]

## Core challenge: Occlusions



## Core challenge: Occlusions

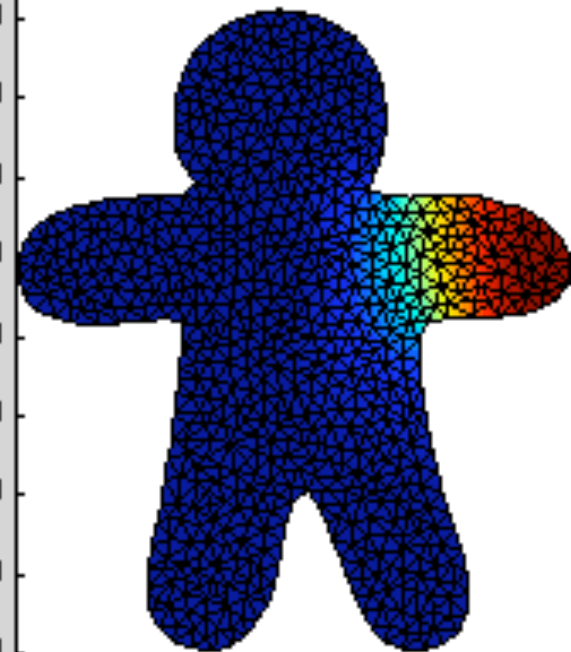
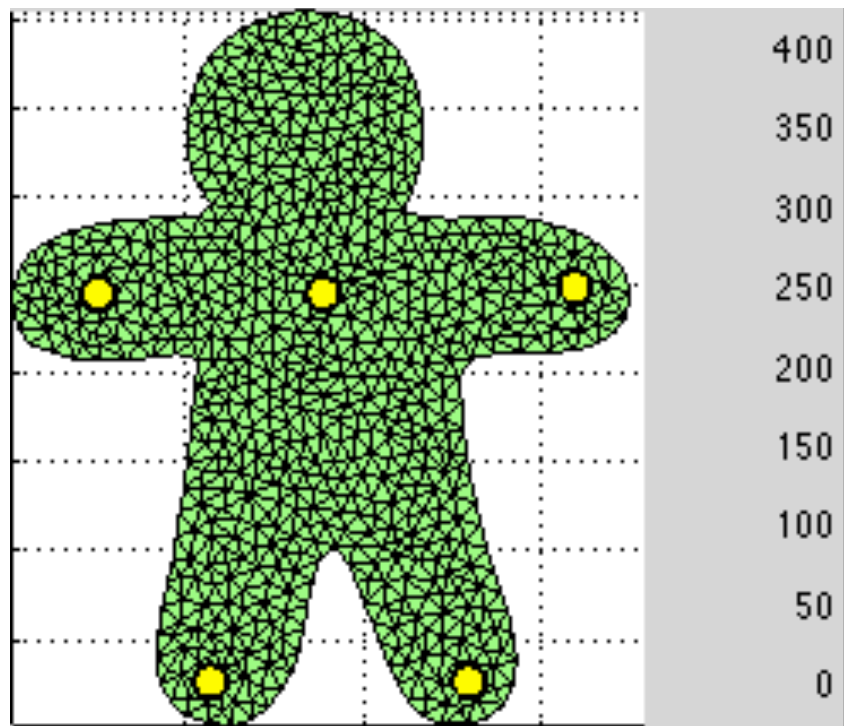

[Jacobson et al. 2011]

# core challenges of sketches and some solutions

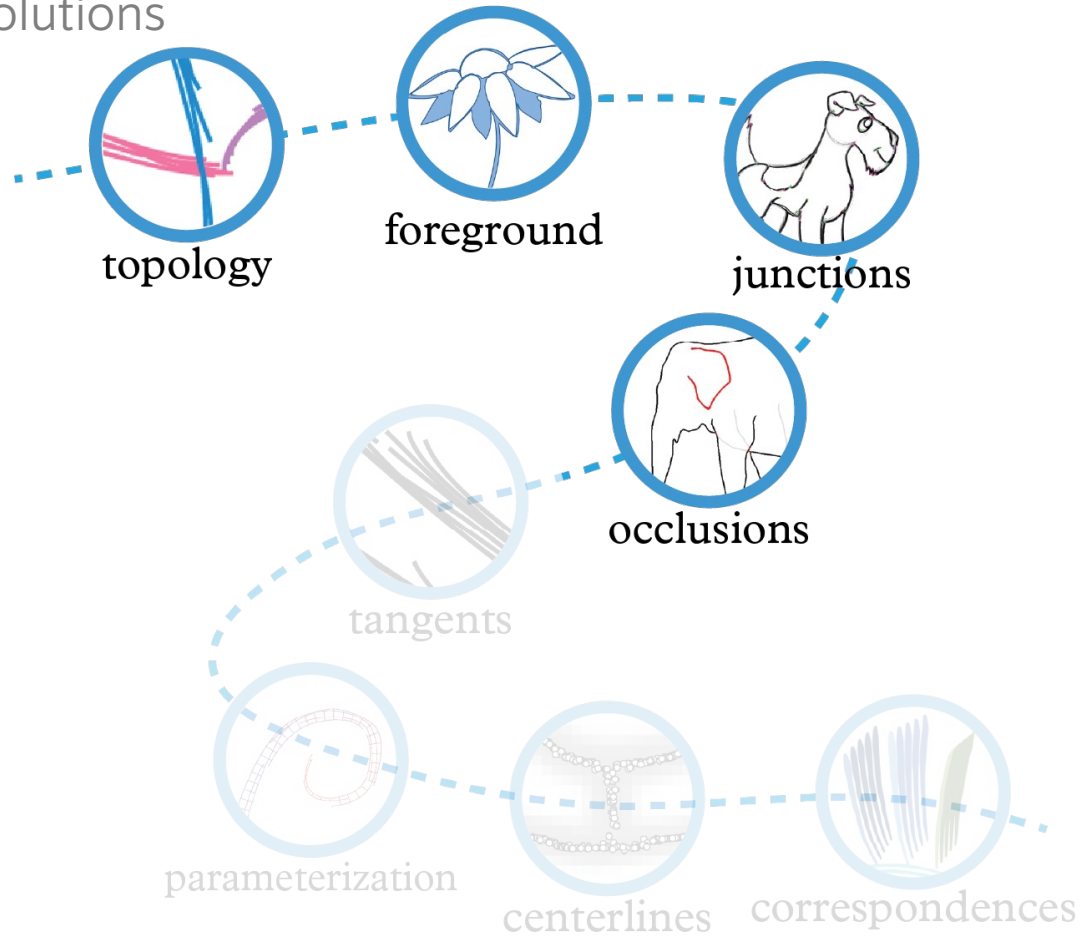

# core challenges of sketches and some solutions

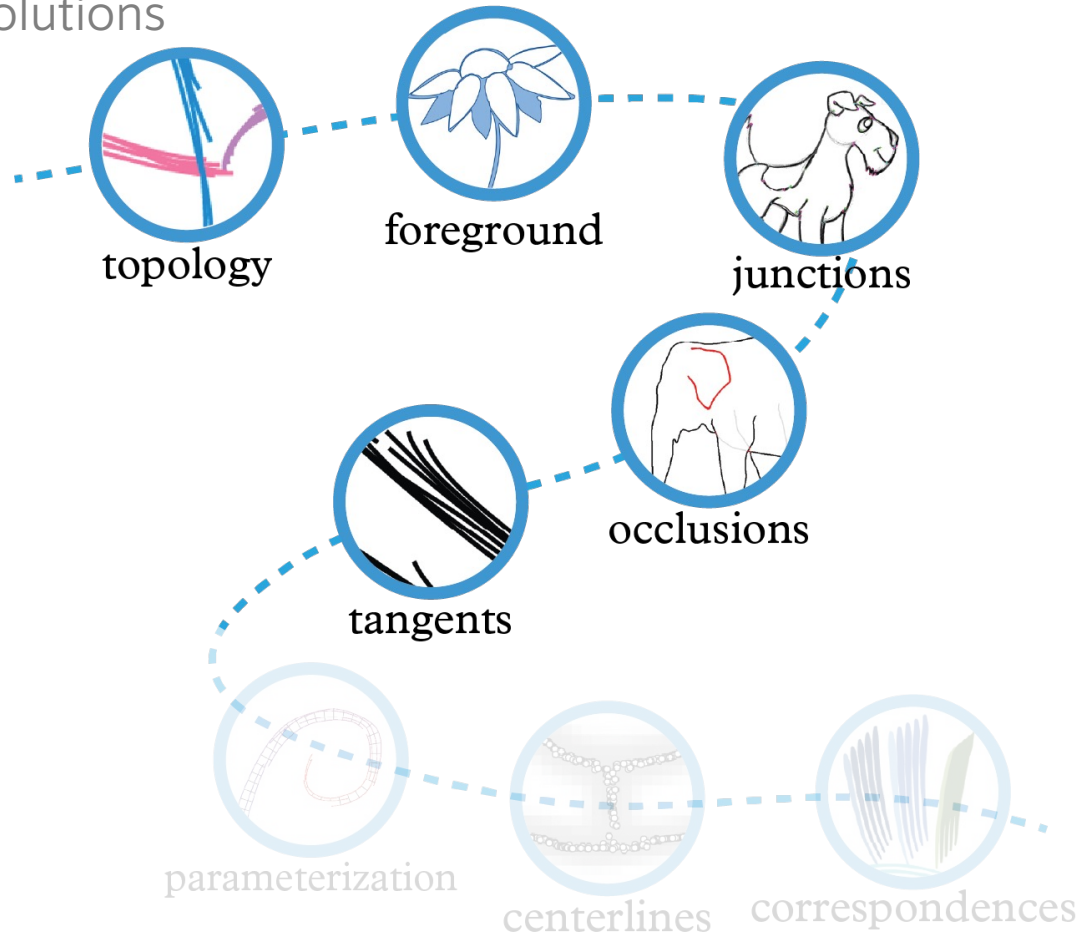

## Core challenge: Tangents?

Tangents near endpoints and junctions

Tangents of overdrawn strokes



## Core challenge: Tangents?

Tangents near endpoints and junctions

Tangents of overdrawn strokes



## Core challenge: Tangents?

Tangents near endpoints and junctions

Tangents of overdrawn strokes





## Core challenge: Tangents?

Tangents near endpoints and junctions

Tangents of overdrawn strokes

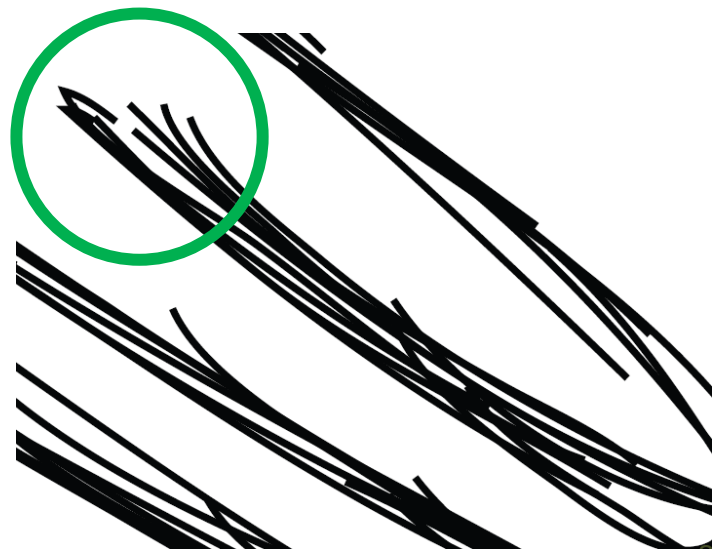

## Core challenge: Tangents?

Tangents near endpoints and junctions

Tangents of overdrawn strokes

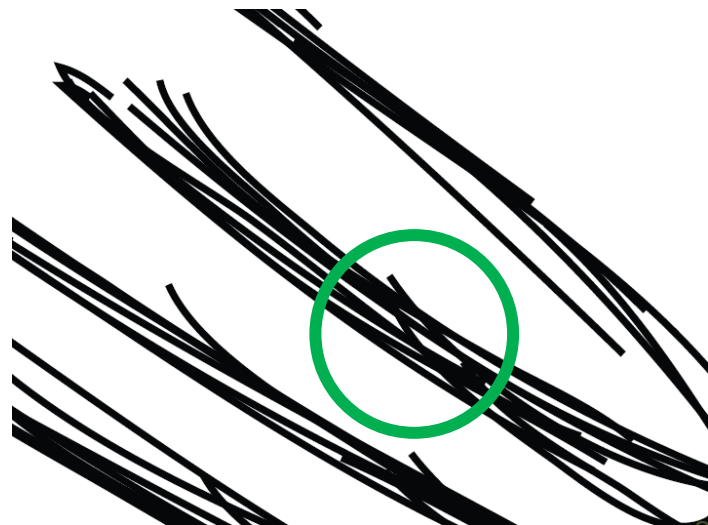

# Tangents | **Solution:** Directional and frame fields

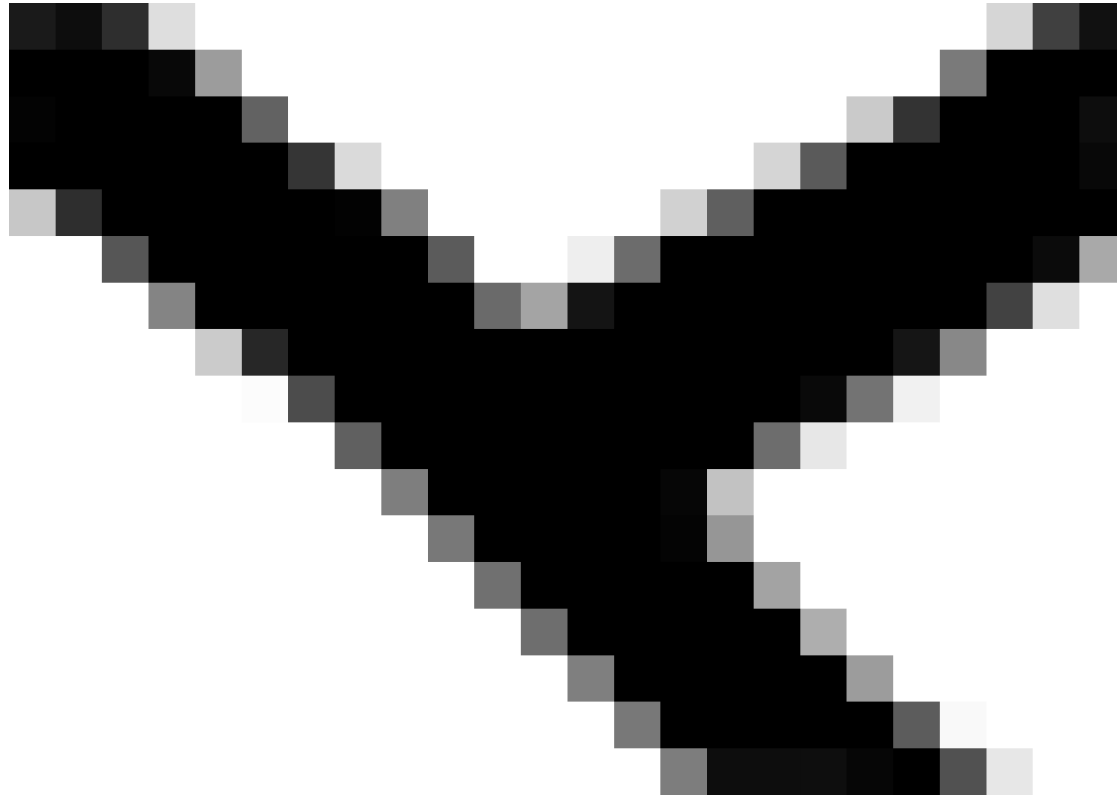

# Tangents | **Solution:** Directional and frame fields

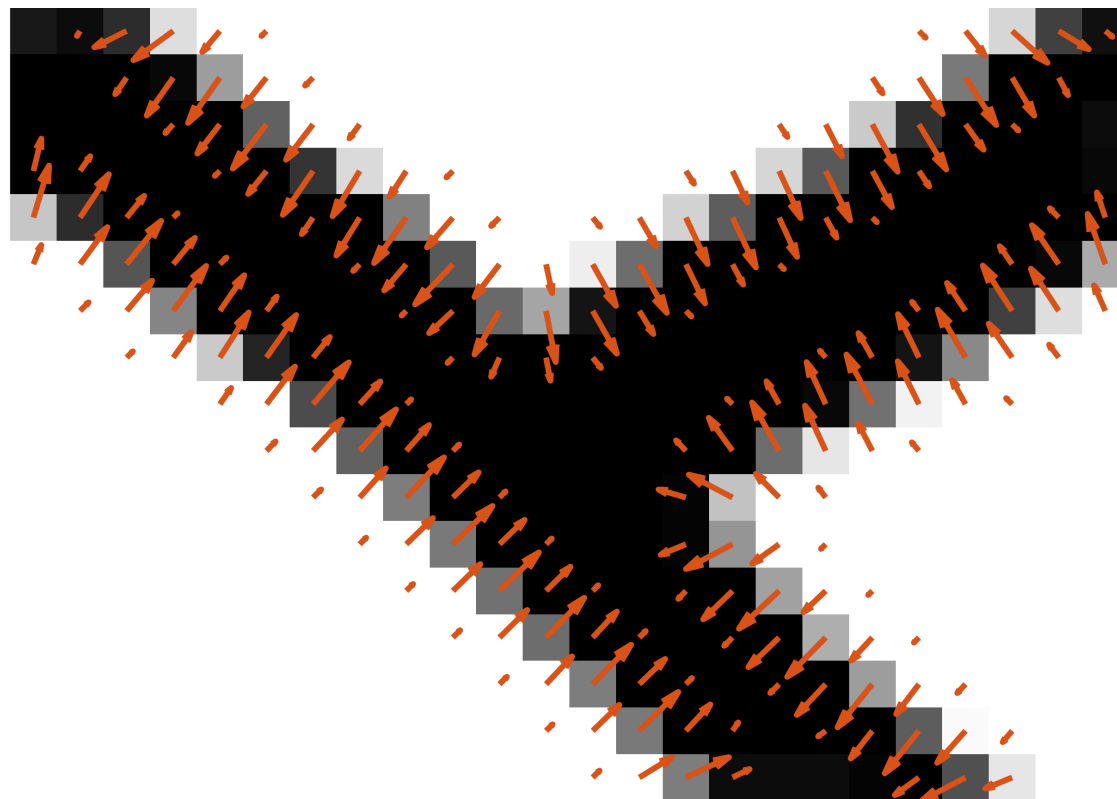

$$\nabla I$$

# Tangents | **Solution:** Directional and frame fields

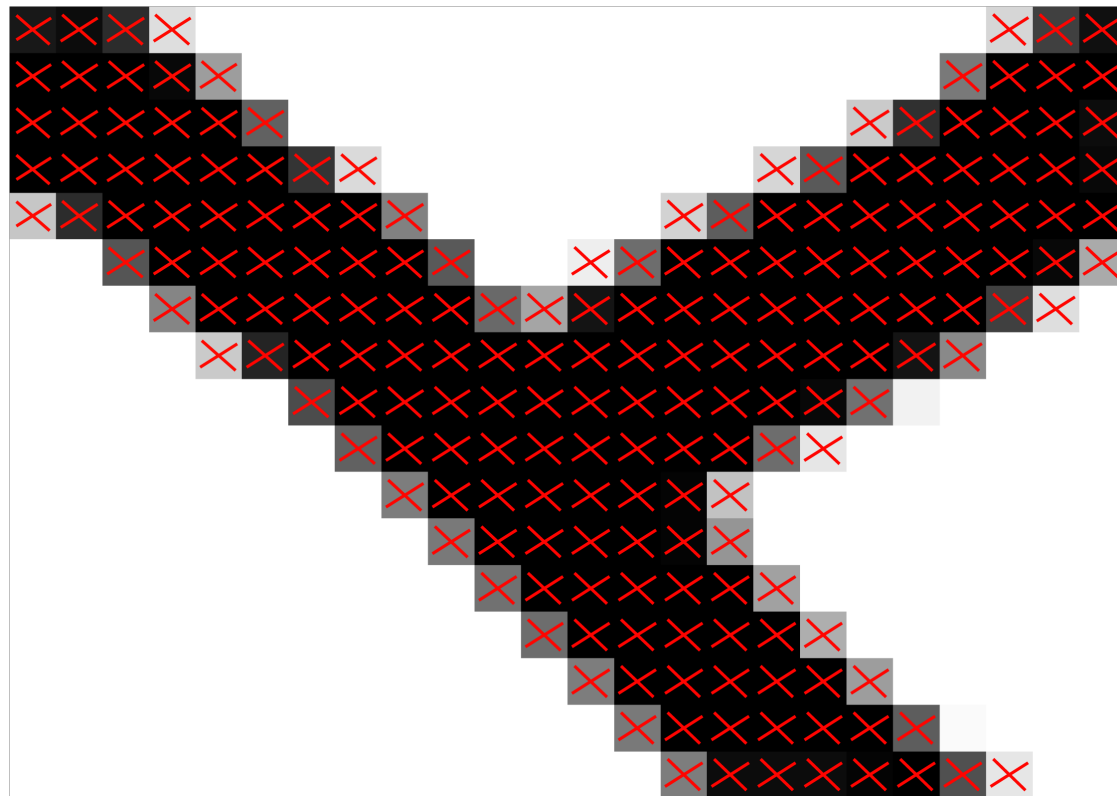

# Tangents | **Solution:** Directional and frame fields

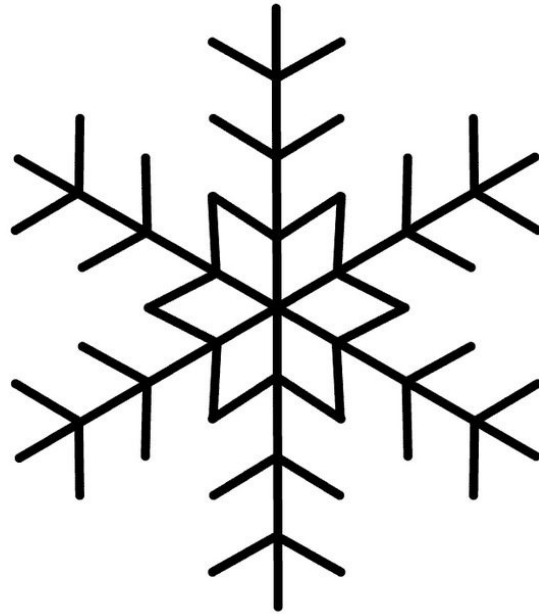

# core challenges of sketches and some solutions

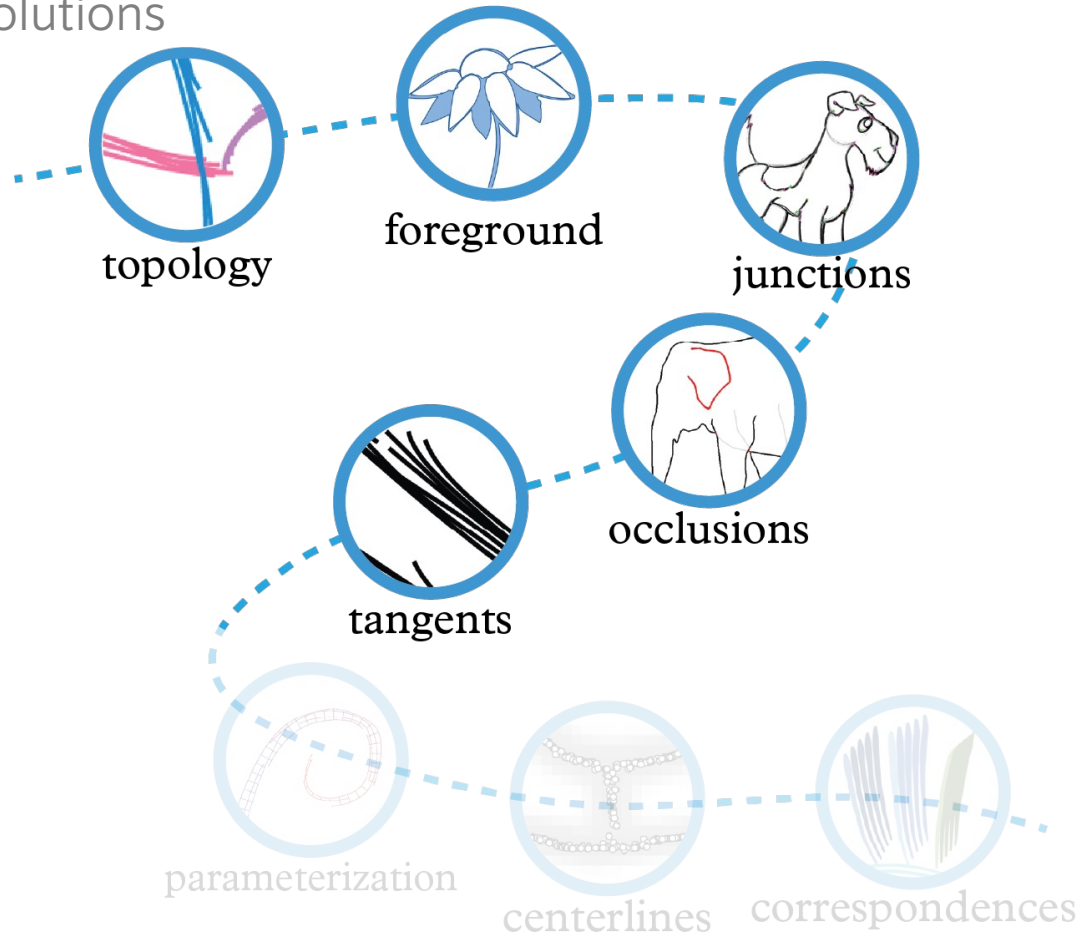

# core challenges of sketches and some solutions

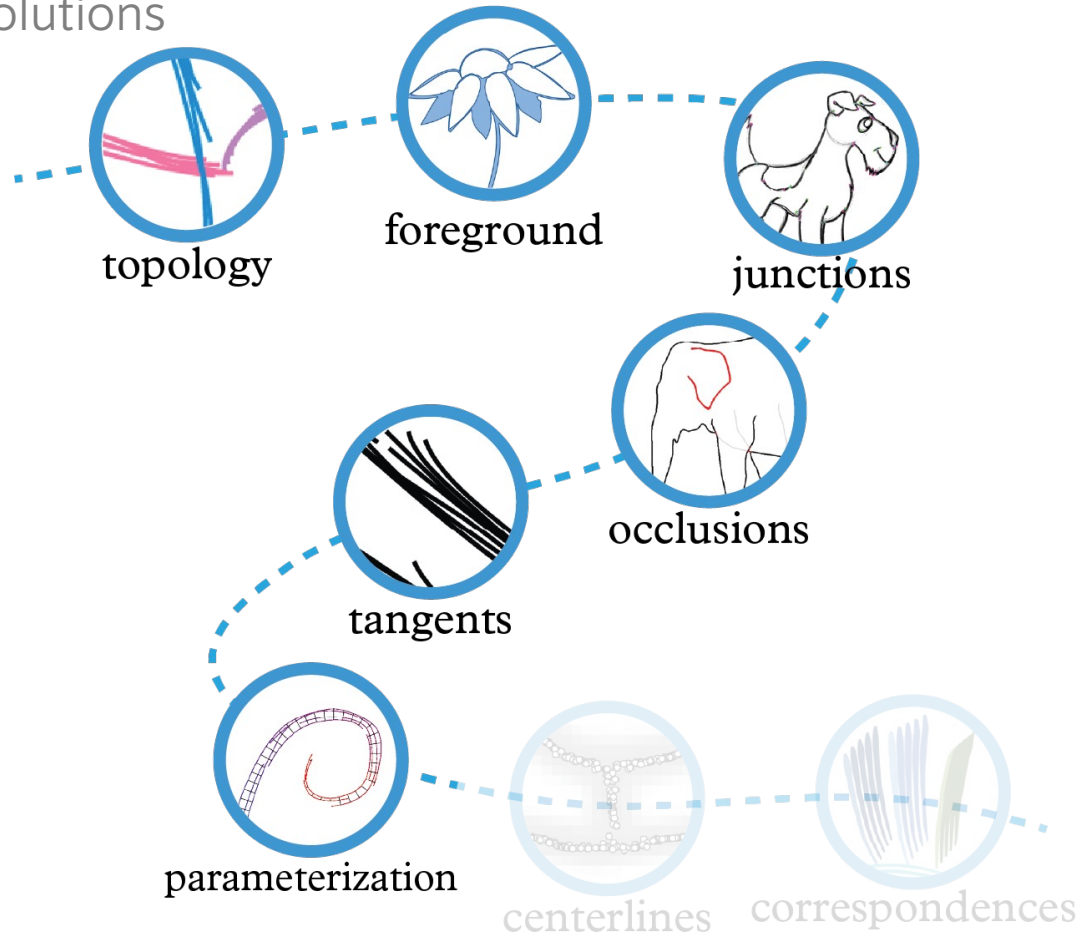



# Core challenge: Parameterization

Arclength parameterization of a cluster

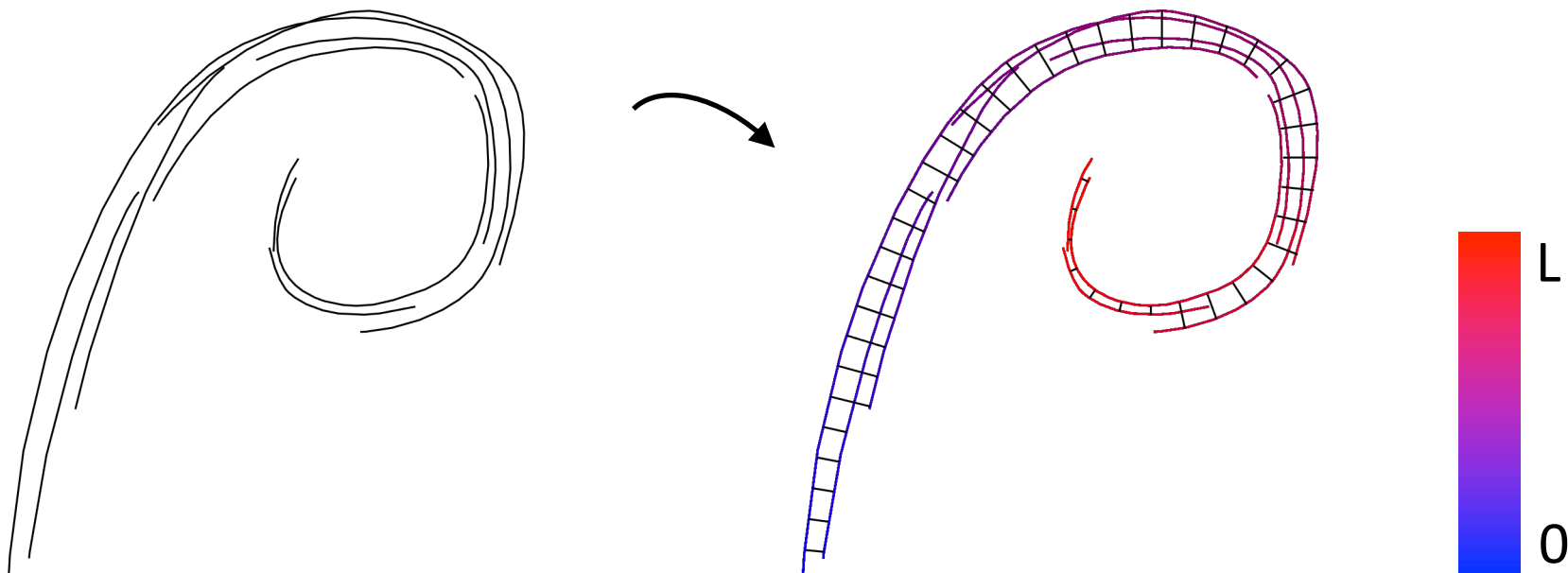

[van Mossel et al. 2021]

# Parameterization | Solution: Eikonal equation

$$\|\nabla u\|_2 = 1$$

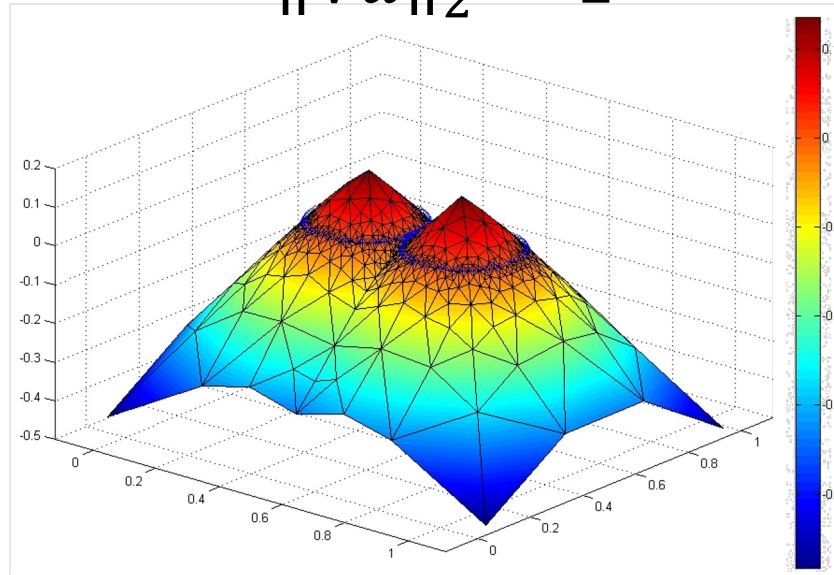

[https://www.mathworks.com/matlabcentral/fileexchange/24827-hamilton-jacobi-solver-on-unstructured-triangular-grids/content/HJB\\_Solver\\_Package/@SolveEikonal/SolveEikonal.m](https://www.mathworks.com/matlabcentral/fileexchange/24827-hamilton-jacobi-solver-on-unstructured-triangular-grids/content/HJB_Solver_Package/@SolveEikonal/SolveEikonal.m)

# core challenges of sketches and some solutions

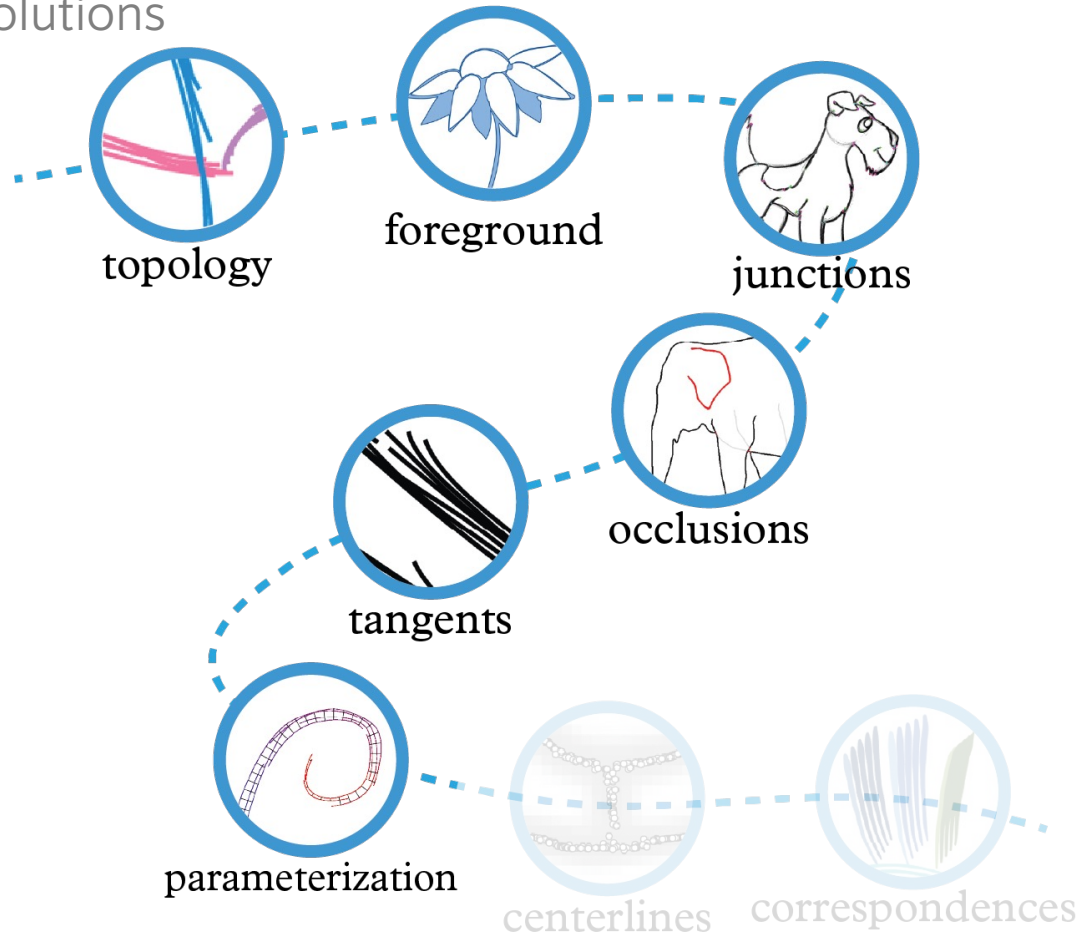

# core challenges of sketches and some solutions

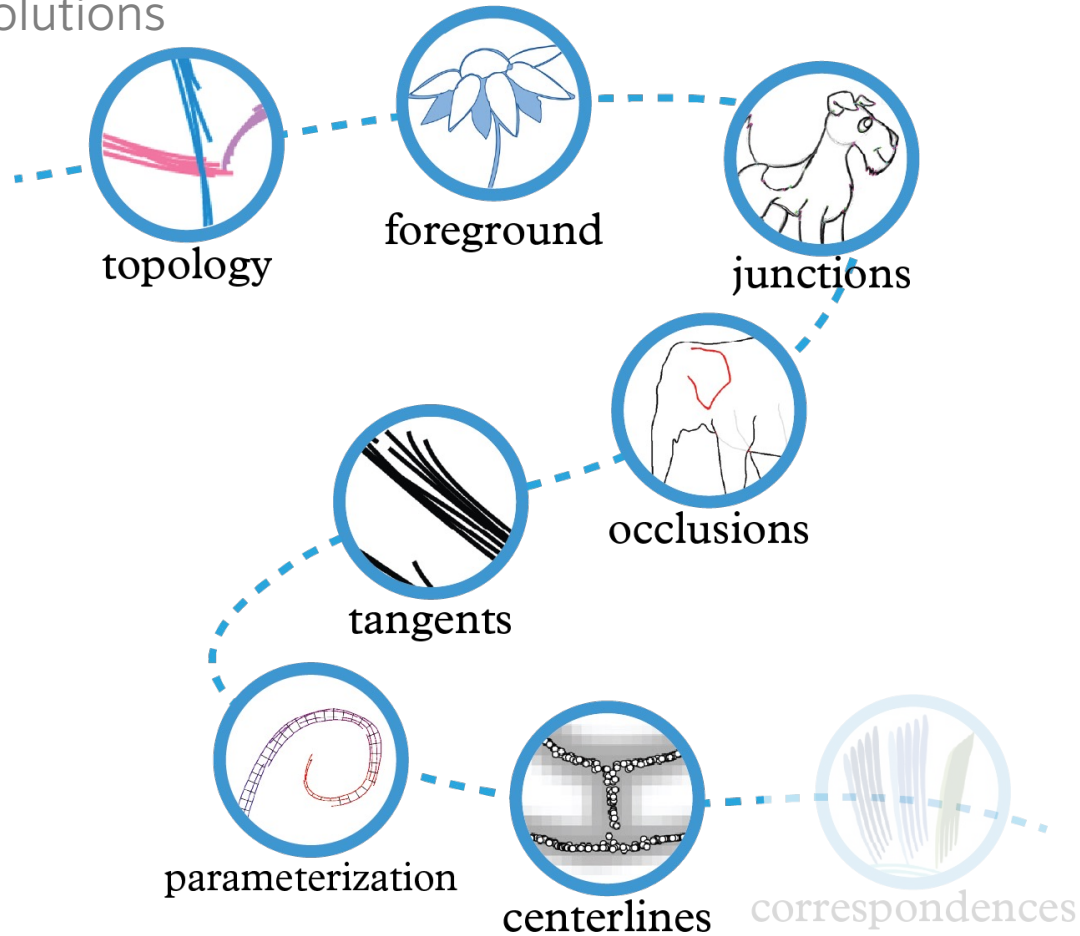

## Core challenge: Centerlines

Find centerlines of a bitmap line drawing

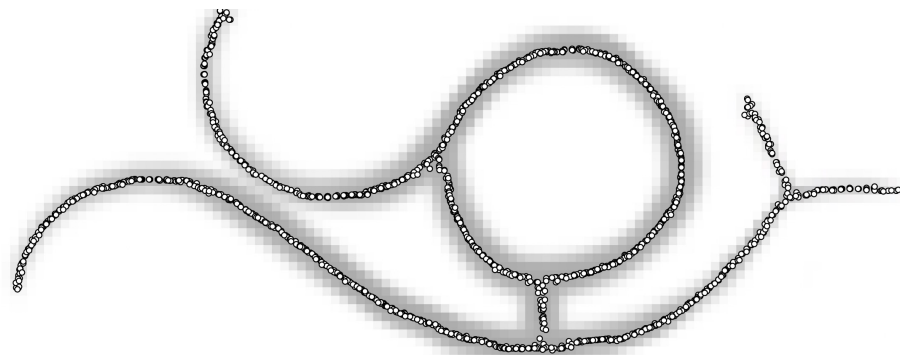
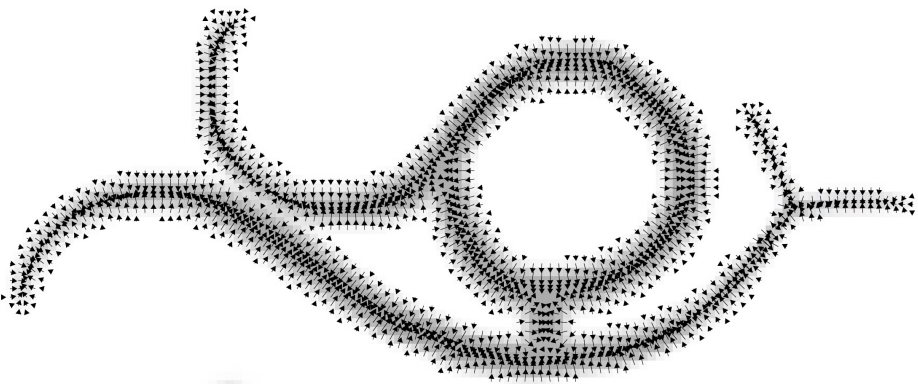

# Centerlines | **Solution:** Gradient descent

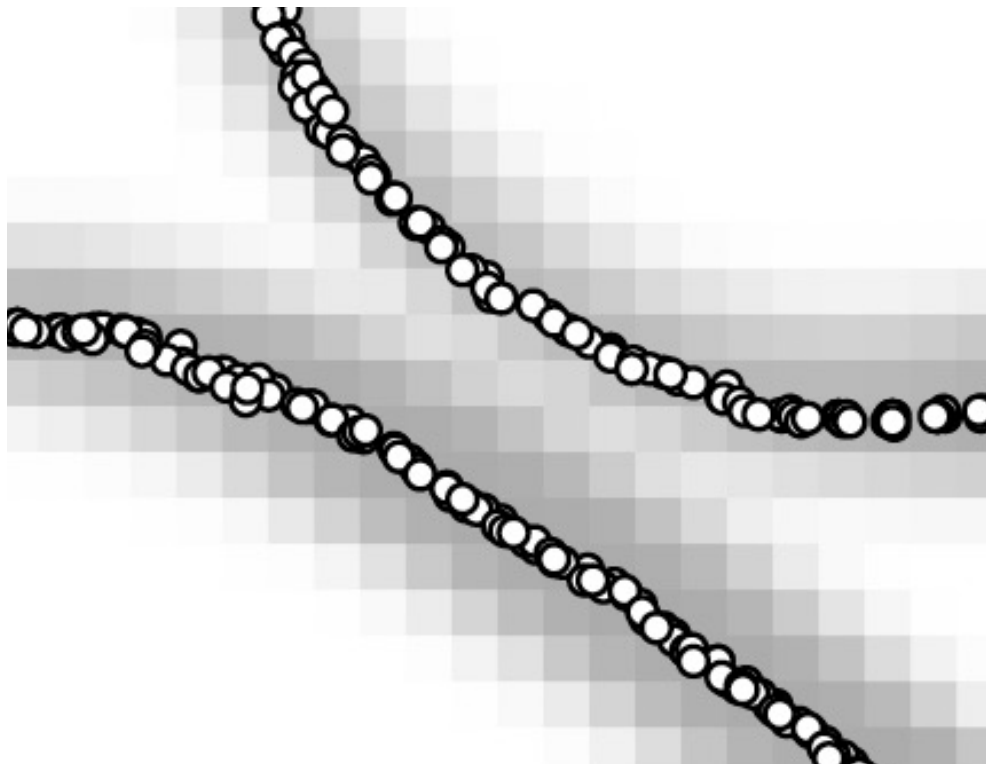
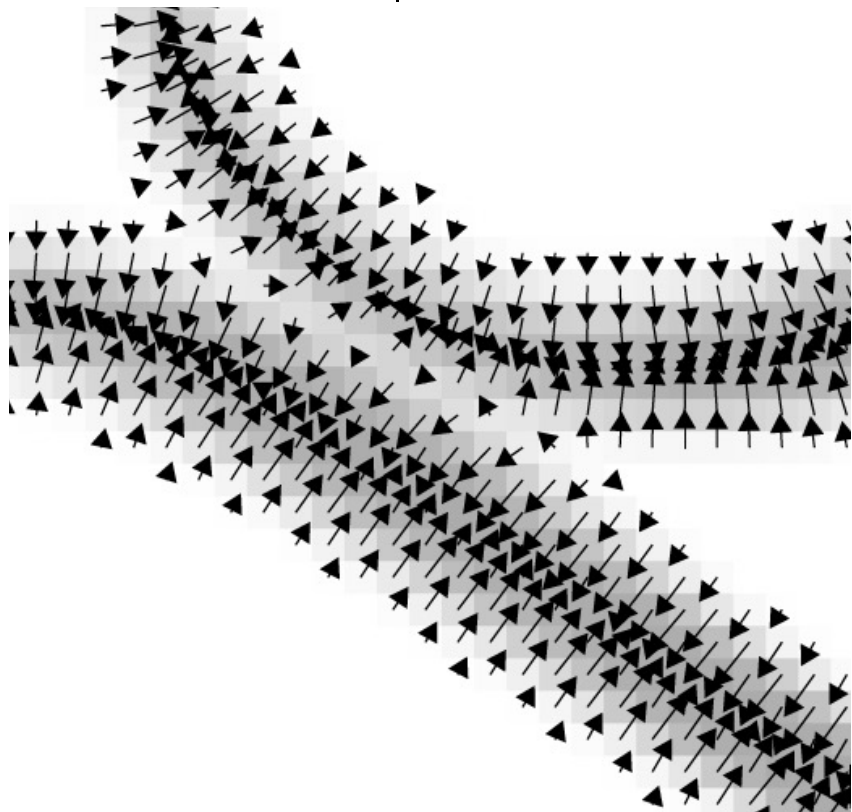

# Centerlines | **Solution:** Unsigned distance field

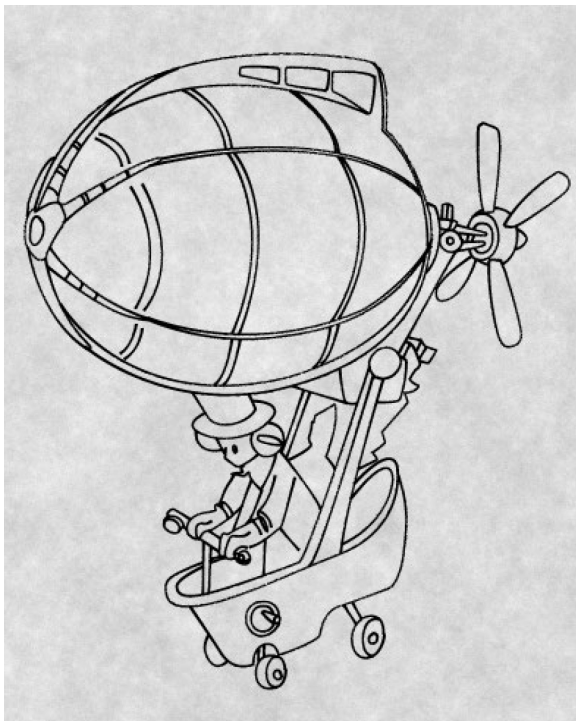

Image © David Revoy CC-BY-4.0



[Yan et al. 2024]

# Core challenge: Stroke vs Fill?



Image © Andreas von Buddenbrock



## Core challenge: Stroke vs Fill?



# core challenges of sketches and some solutions

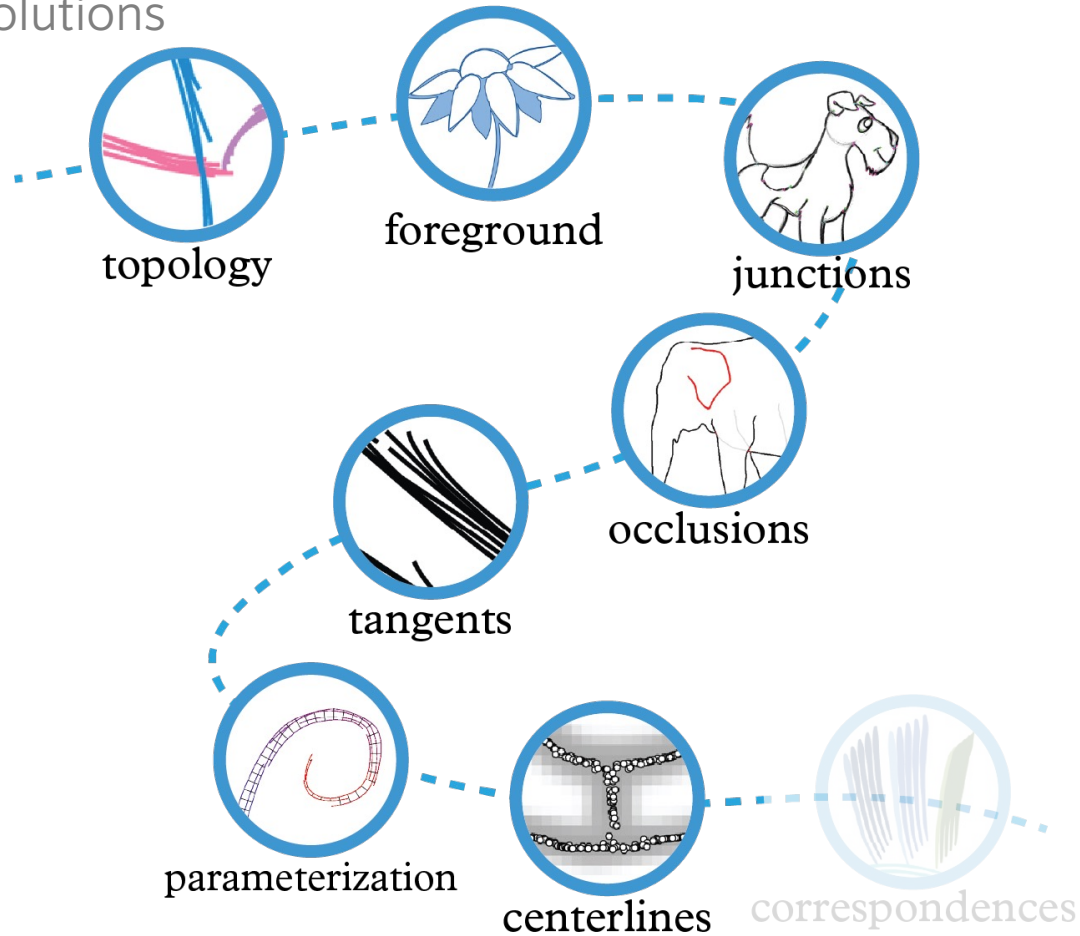

# core challenges of sketches and some solutions

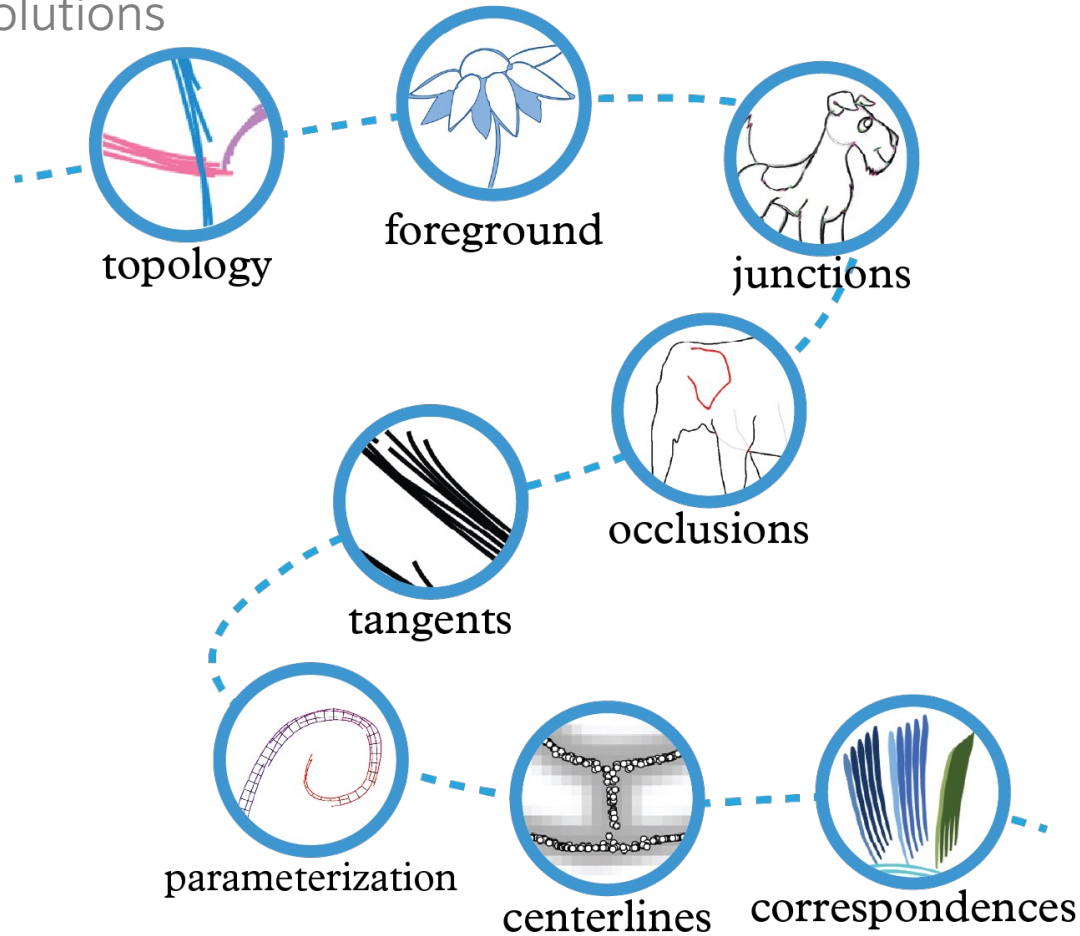

## Core challenge: Correspondences

A correspondence **between strokes** suggests **pointwise correspondence**

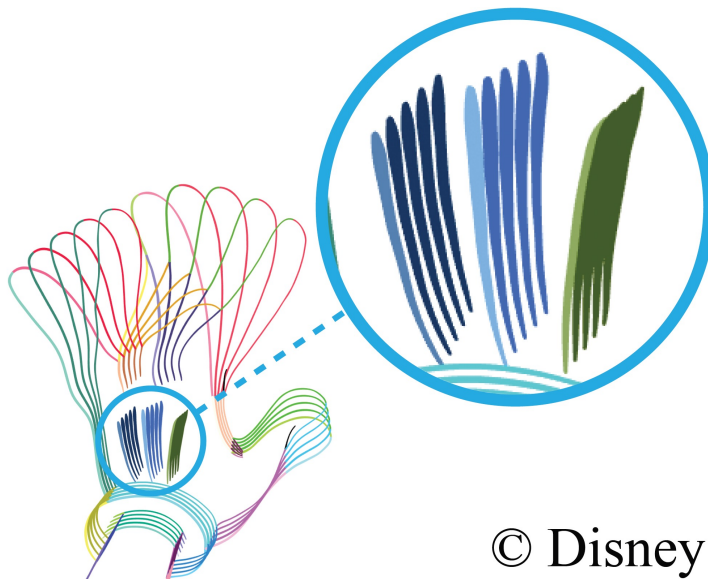

© Disney

[Whited et al. 2010]

## Core challenge: Correspondences

Even more complex when there are occlusions

One-to-many, one-to-nothing

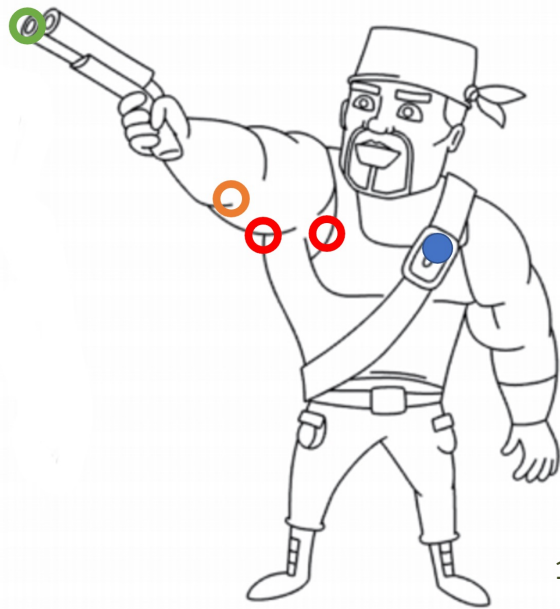

## Correspondences | **Solution: Joint Tracing**

Start with a vectorization of frame 1, try retracing it at frame 2



[Mo et al. 2024], a similar idea in [Noris et al. 2010]

# Correspondences | **Solution:** Optical Flow

A vector field deforming Frame 1 into 2

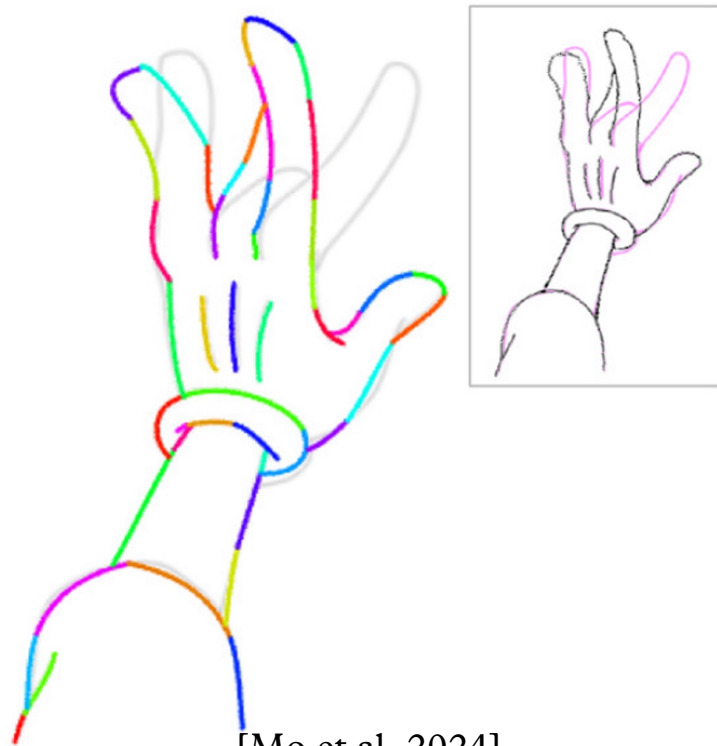

# Correspondences | **Solution:** Deformation

Deform vector frame 1 into bitmap 2  
Differential vector graphics + optimization



[Mo et al. 2024]



# Correspondences | **Solution:** Functional maps

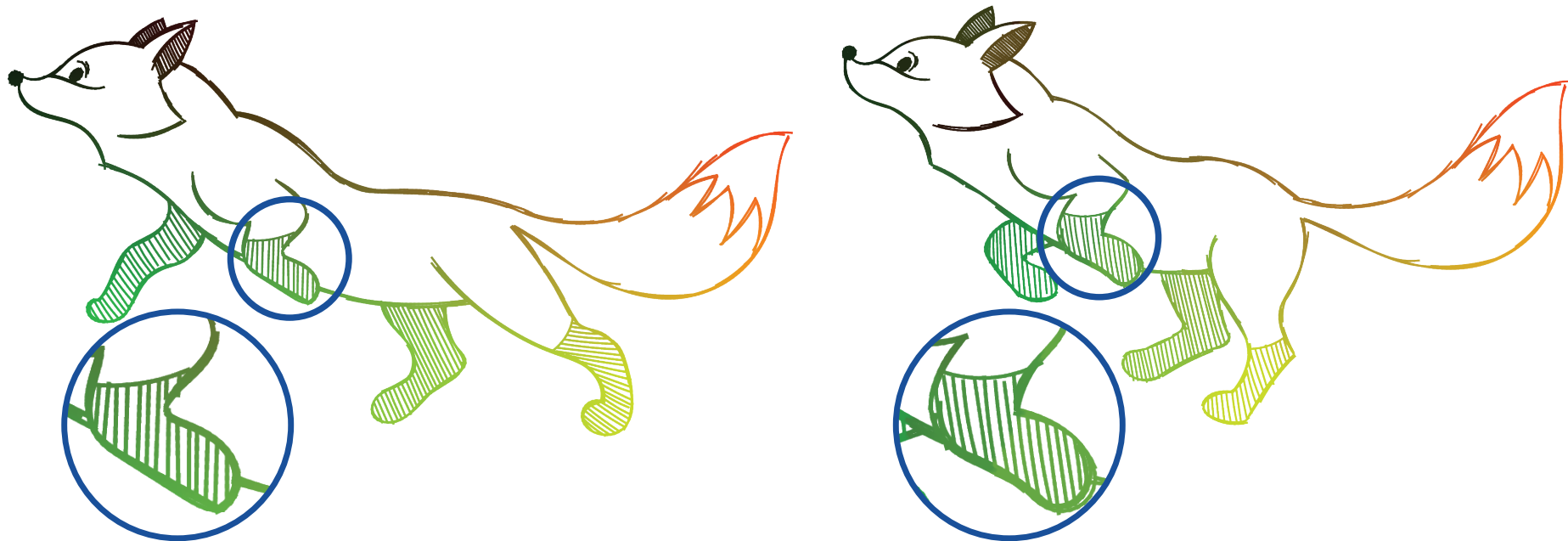

# Checkpoint

Some basic things are really hard for 2D and 3D sketches.

Having principled solution to these core challenges will be a big deal for applications

# Fundamentals and applications of sketch processing

Lots of hard problems

Uncharted territories with topology and geometry ideas lurking

Not everything (yet) is deep learning

# Fundamentals and Applications of Sketch Processing

Mikhail (Misha) Bessmeltsev & Chenxi Liu



UNIVERSITY OF  
TORONTO