

IFT 6113

MESH PARAMETERIZATION

tiny.cc/ift6113

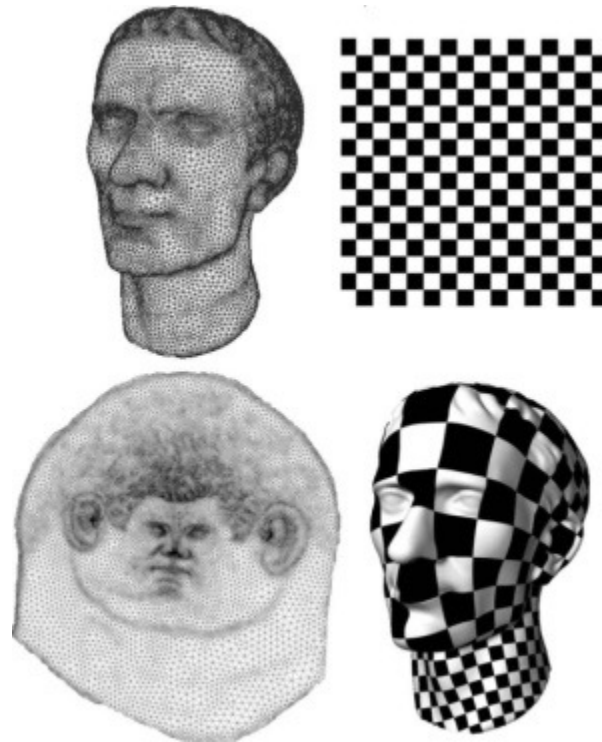
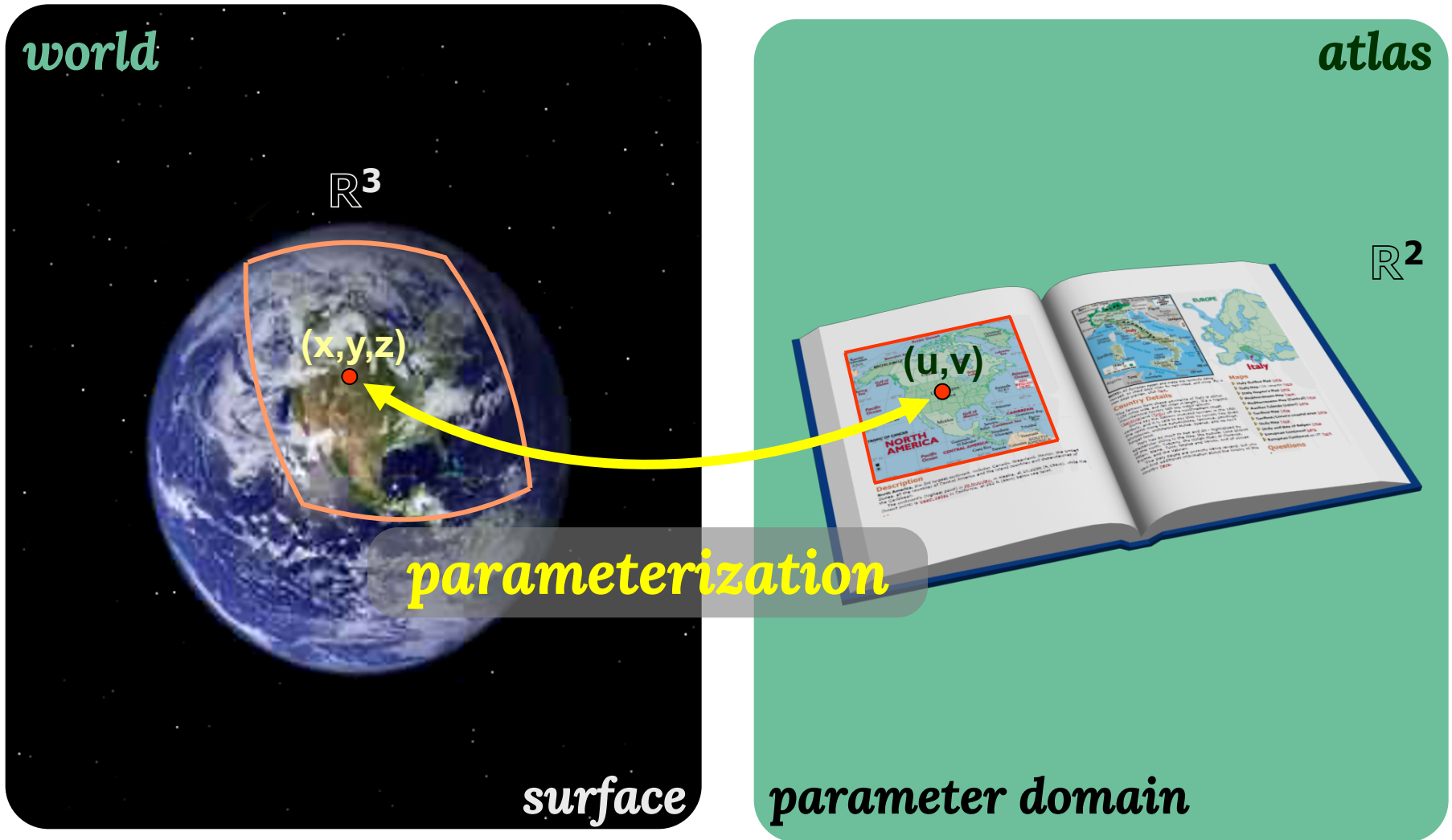

Image from https://doc.cgal.org/latest/Surface_mesh_parameterization/index.html

Mikhail Bessmeltsev

What is Parameterization?



Problem Definition

Given: surface $S \subseteq \mathbb{R}^3$

domain $D \subset \mathbb{R}^2$

Find a bijective $f: S \rightarrow D$

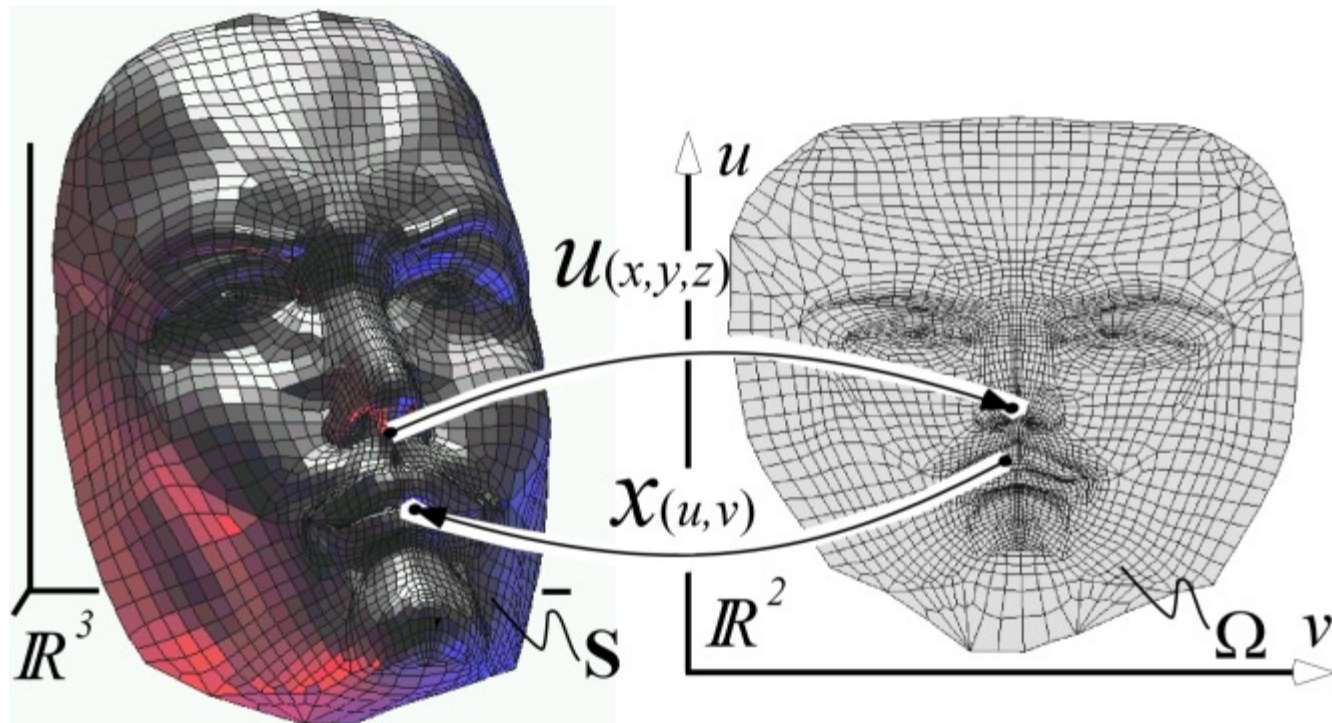

Recall:

Tangent Space

$$T_p S := \text{Image}(D\sigma_u)$$

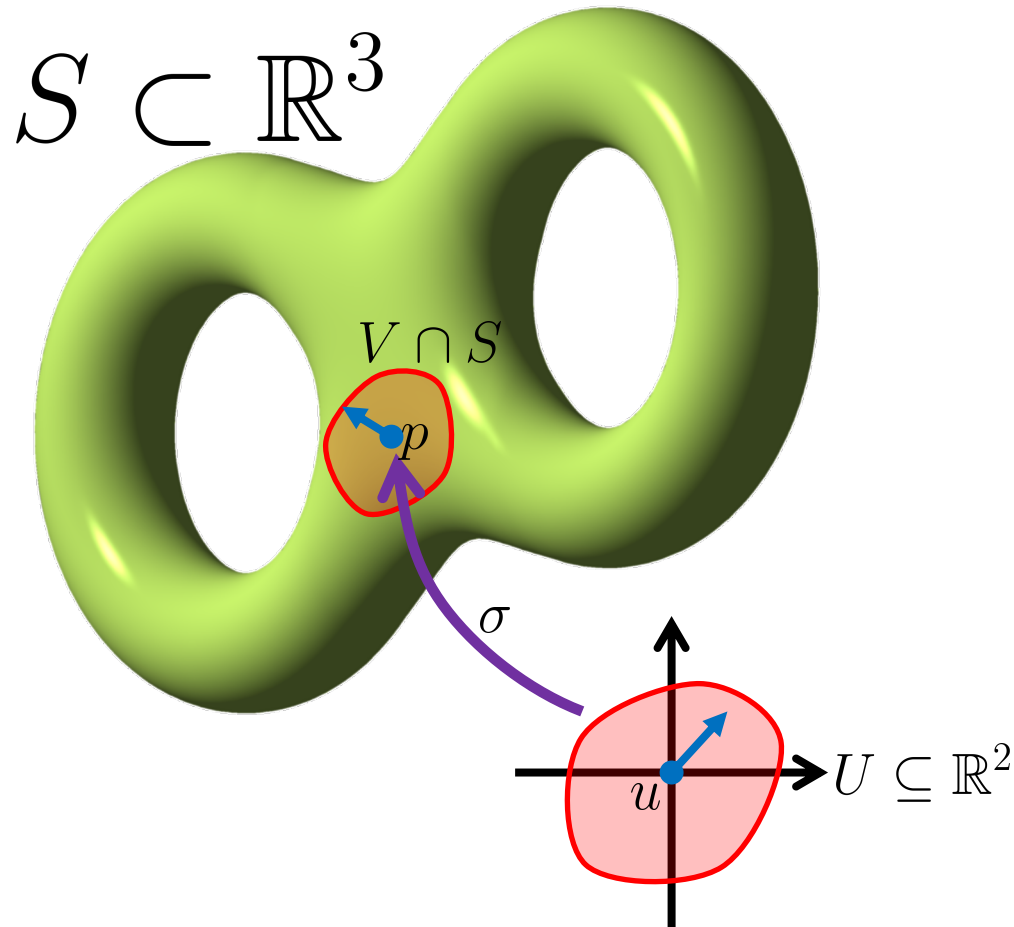

Typical domains:

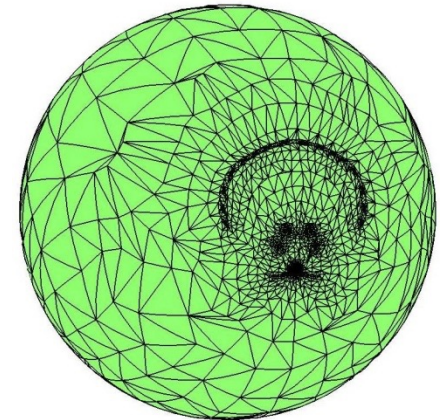
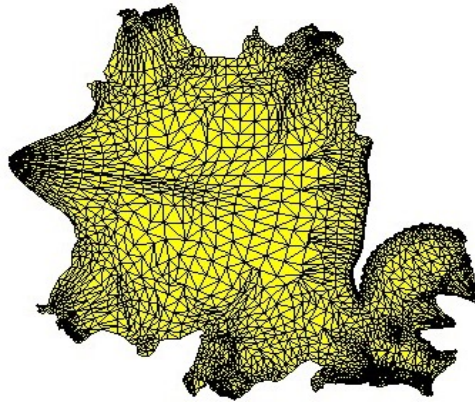
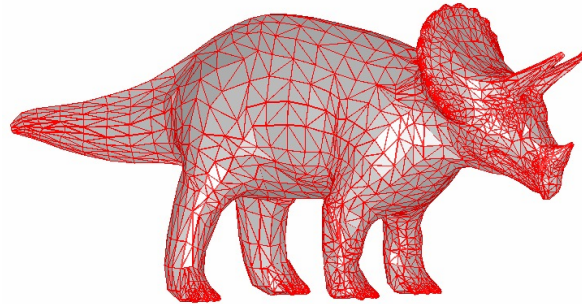

$\subseteq R^2$
boundary

Sphere (no boundary)

Typical domains:

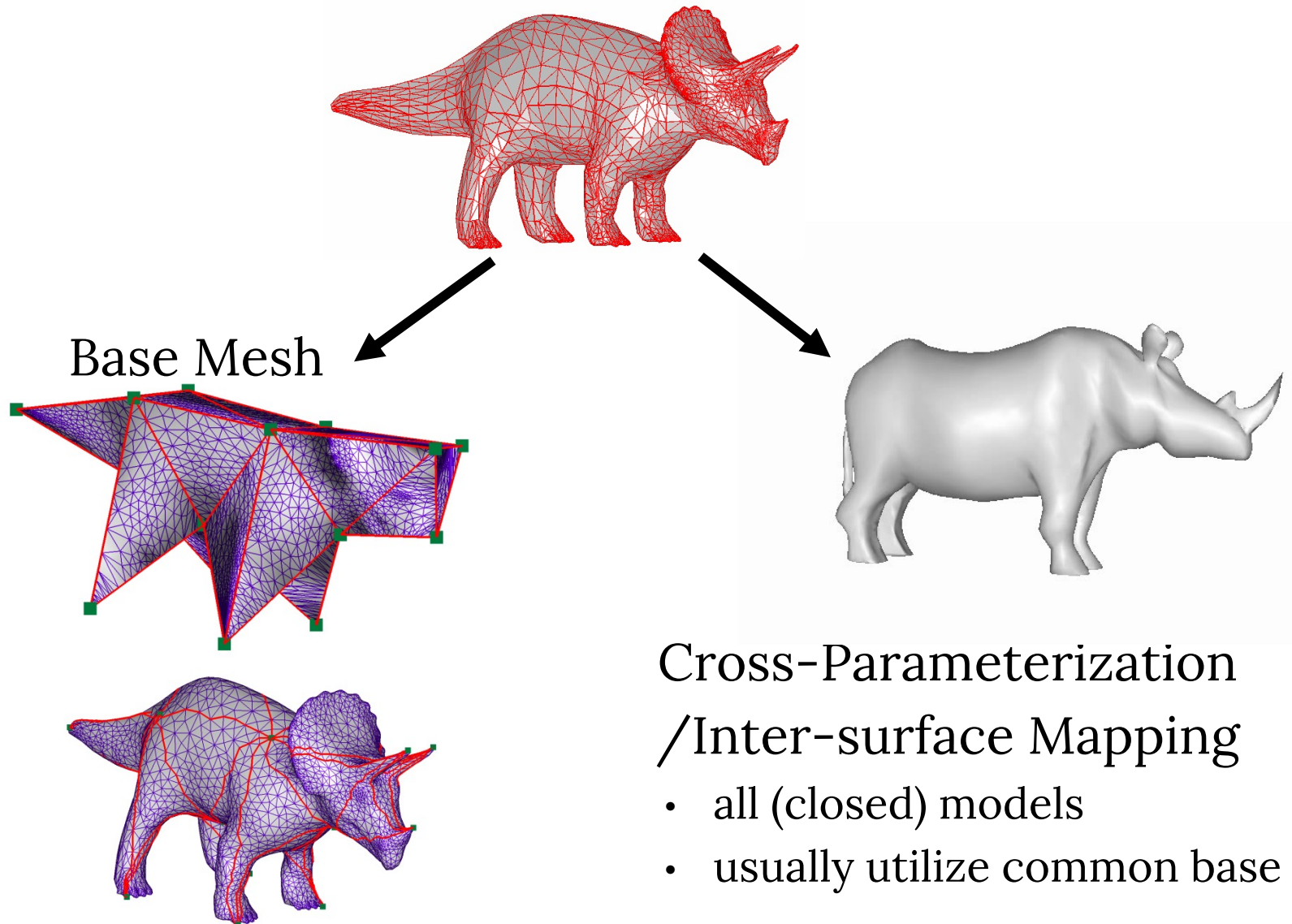

Why Do We Need It?

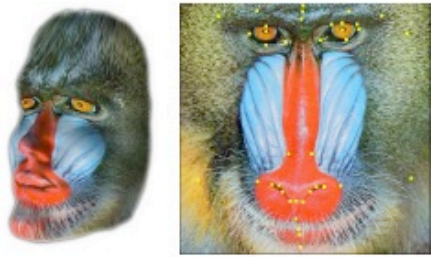

Texture Mapping

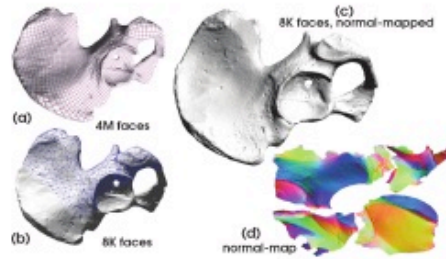

Normal Mapping

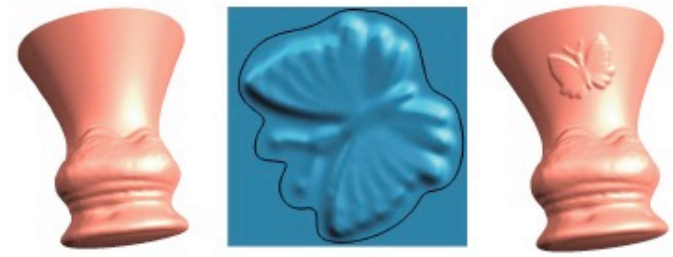

Detail Transfer

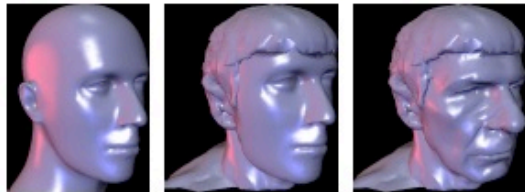

Morphing



Mesh Completion

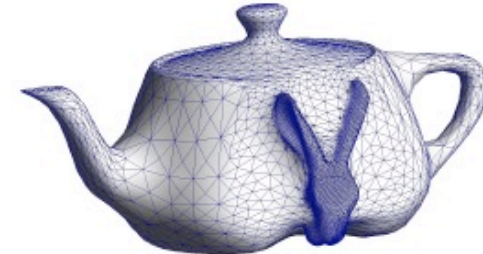

Editing

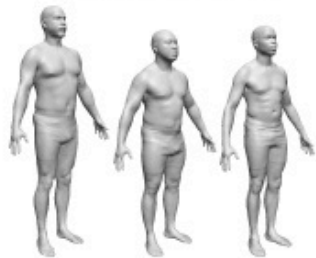

Databases



Remeshing

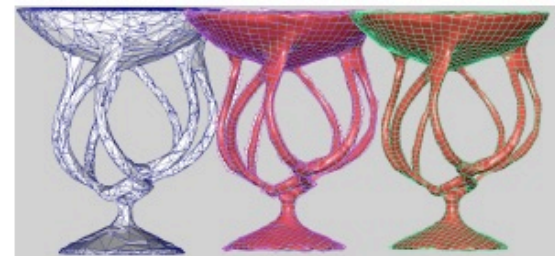

Surface Fitting

Why Do We Need It?

AtlasNet: A Papier-Mâché Approach to Learning 3D Surface Generation

Thibault Groueix^{1*}, Matthew Fisher², Vladimir G. Kim², Bryan C. Russell², Mathieu Aubry¹

¹LIGM (UMR 8049), École des Ponts, UPE, ²Adobe Research

<http://imagine.enpc.fr/~groueixt/atlasnet/>

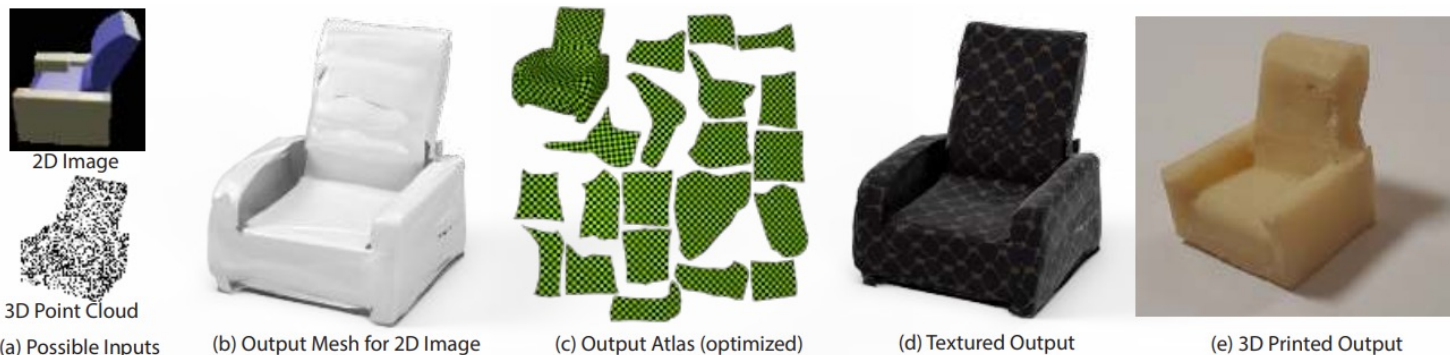
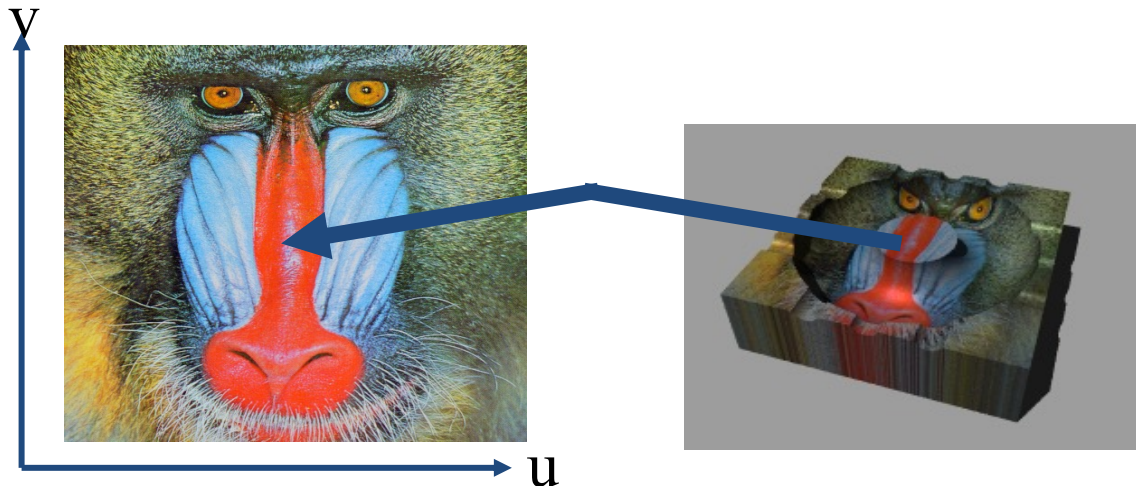

Figure 1. Given input as either a 2D image or a 3D point cloud (a), we automatically generate a corresponding 3D mesh (b) and its atlas parameterization (c). We can use the recovered mesh and atlas to apply texture to the output shape (d) as well as 3D print the results (e).

Texture Mapping

- Define color for each point on object surface
- Map 2D texture to model surface:
 - Texture pattern defined over 2D domain (u, v)
 - Assign (u, v) coordinates to each point on surface



Normal/Bump mapping

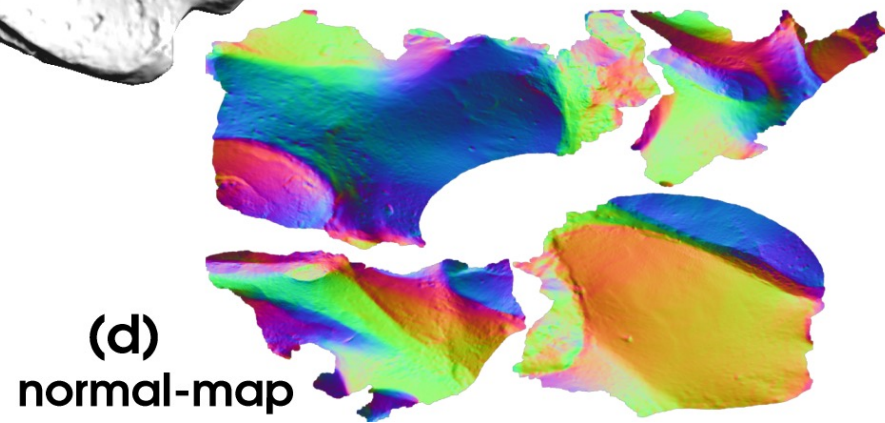
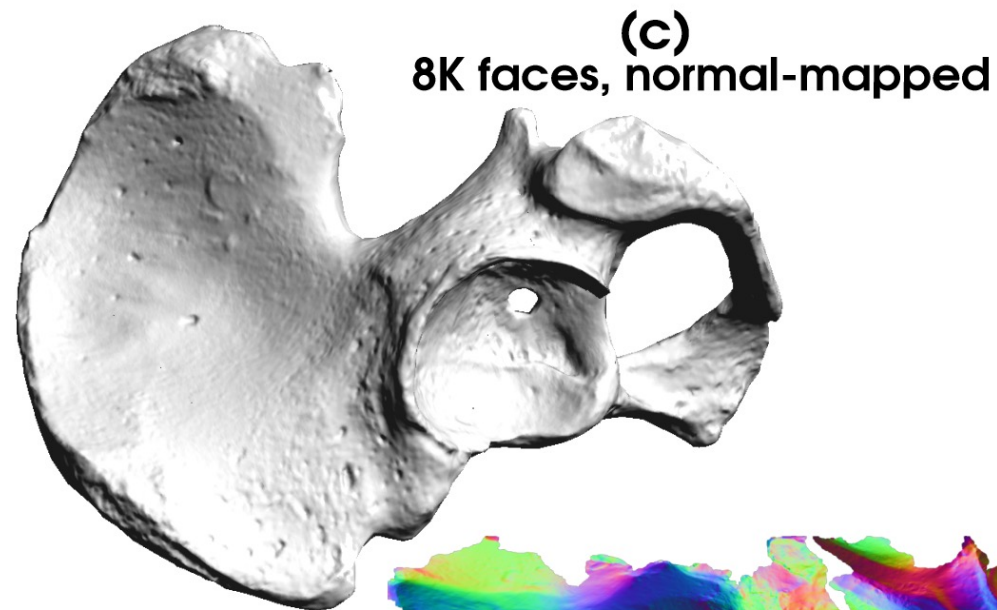
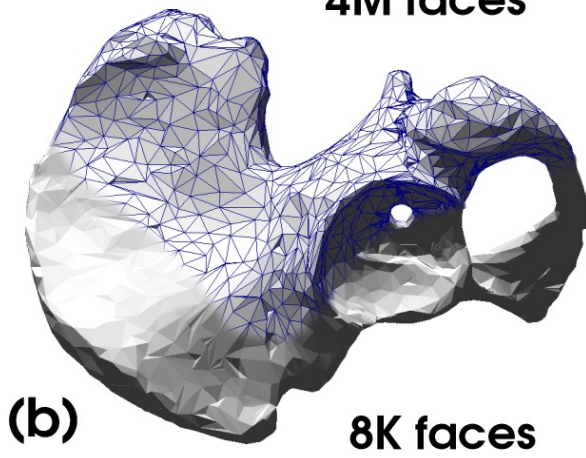
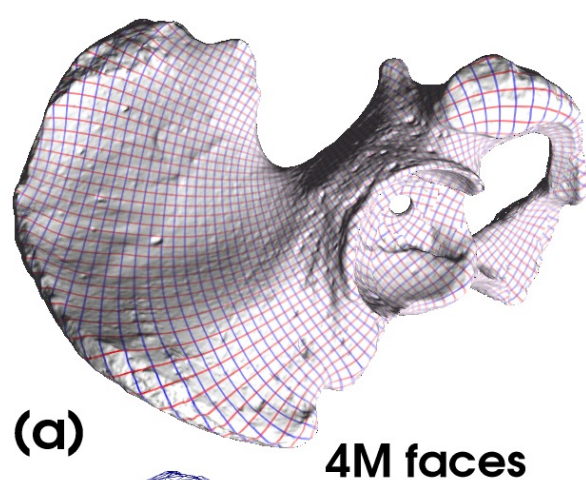

Morphing/Properties Transfer

Require cross-parameterization

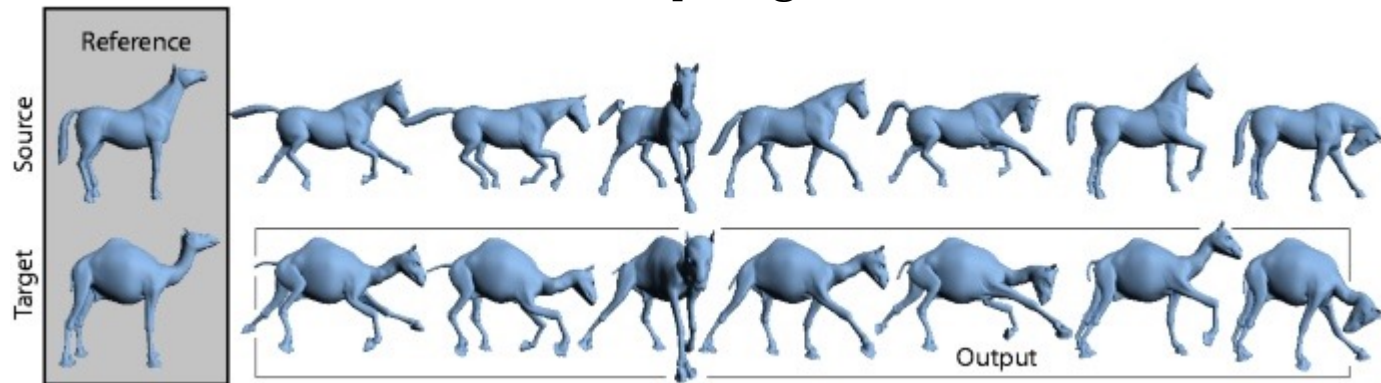
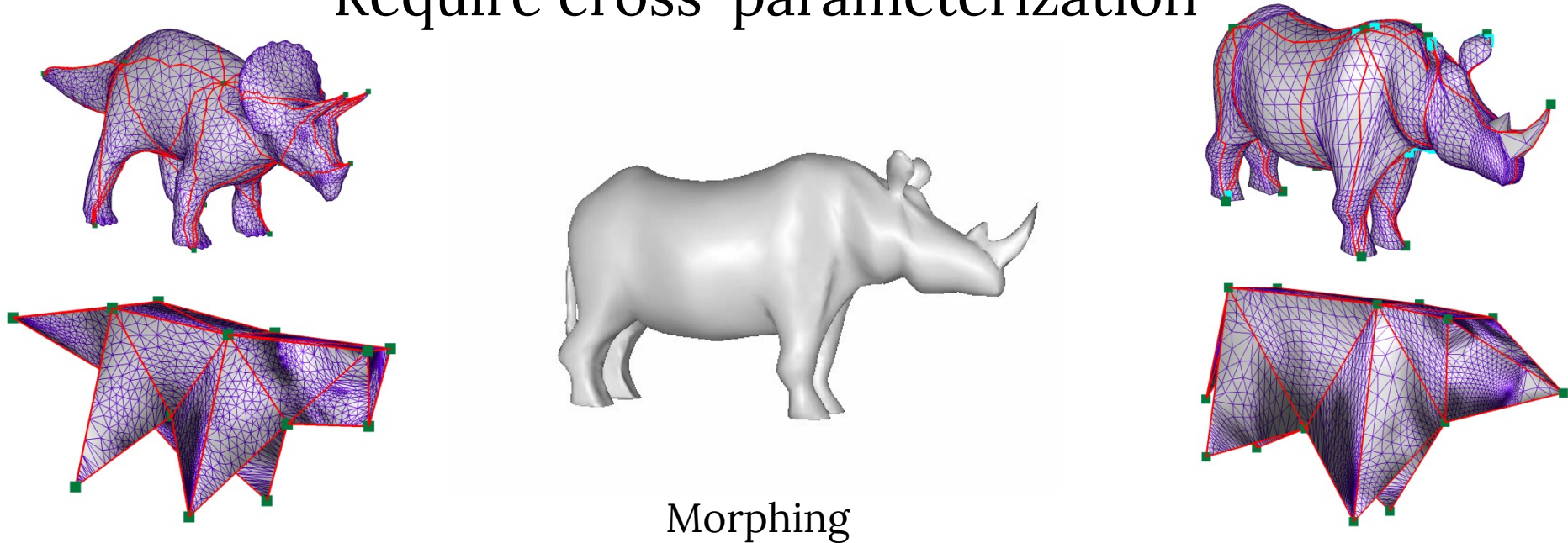

Deformation Transfer

Remeshing & Surface Fitting

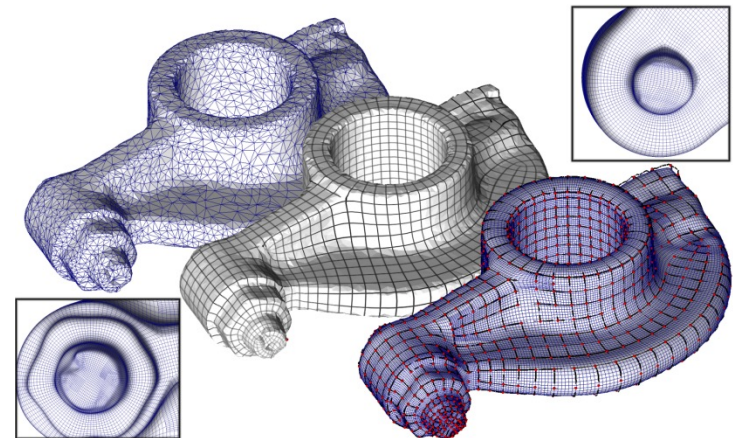
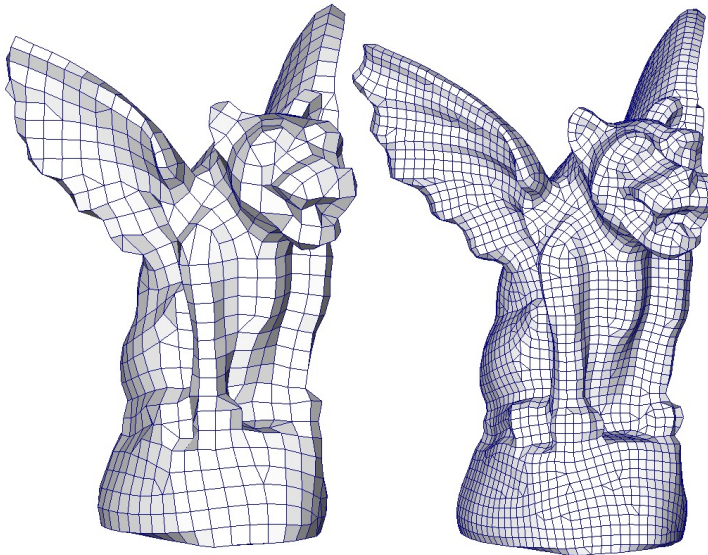
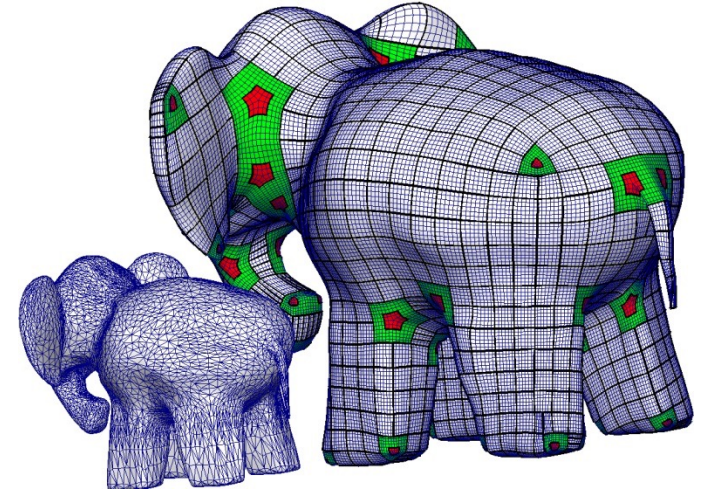
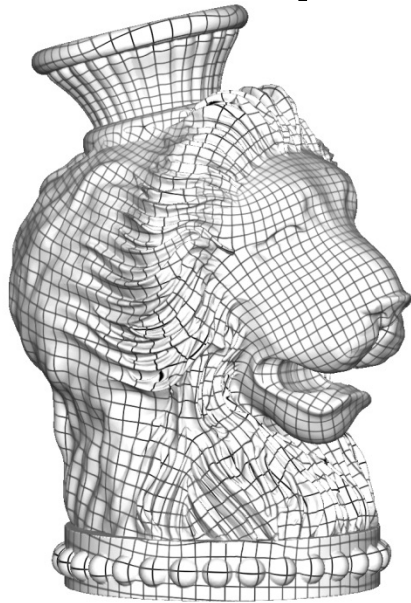

THEORY/BACKGROUND

Mesh Parameterization

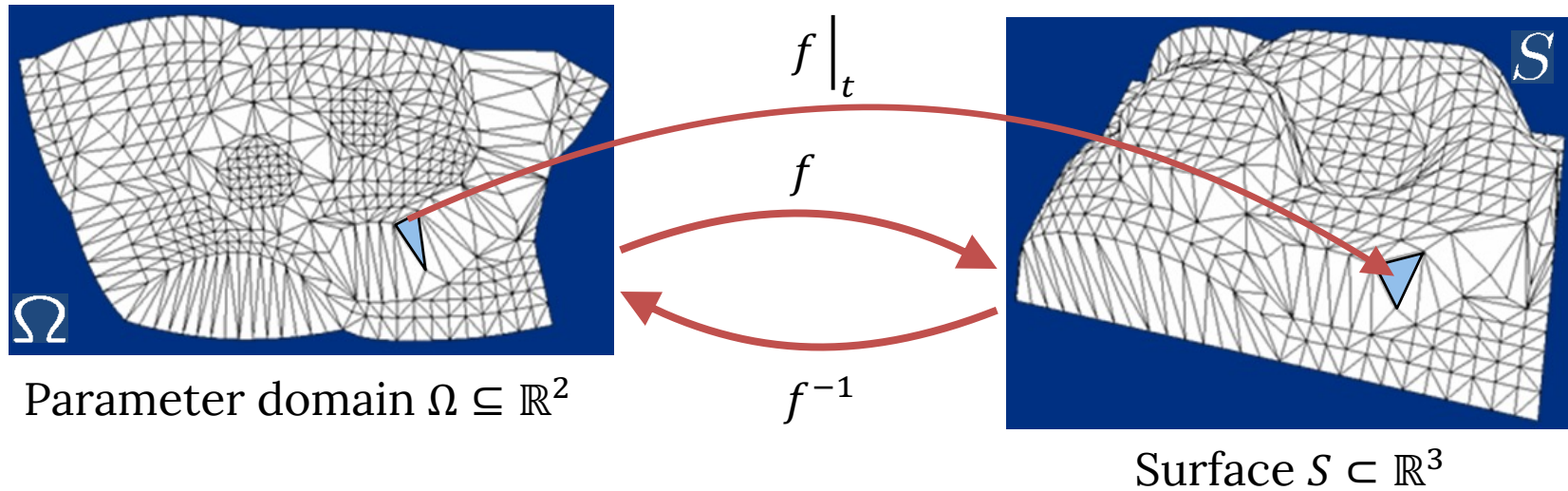

$f: \Omega \rightarrow S$, s. t.

- f is piecewise linear
 - $f|_t$ is linear
- f is **bijective**
 - at least locally

Earth maps!

- Distortion is inevitable
- But we can preserve some properties exactly



orthographic
~ 500 B.C.



stereographic
~ 150 B.C.

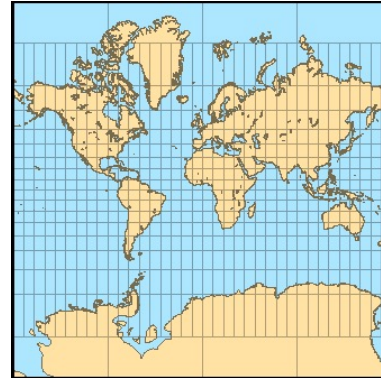

Mercator
1569



Lambert
1772



conformal
(angle-preserving)

equiareal
(area-preserving)

Recall:

Intrinsic Descriptor

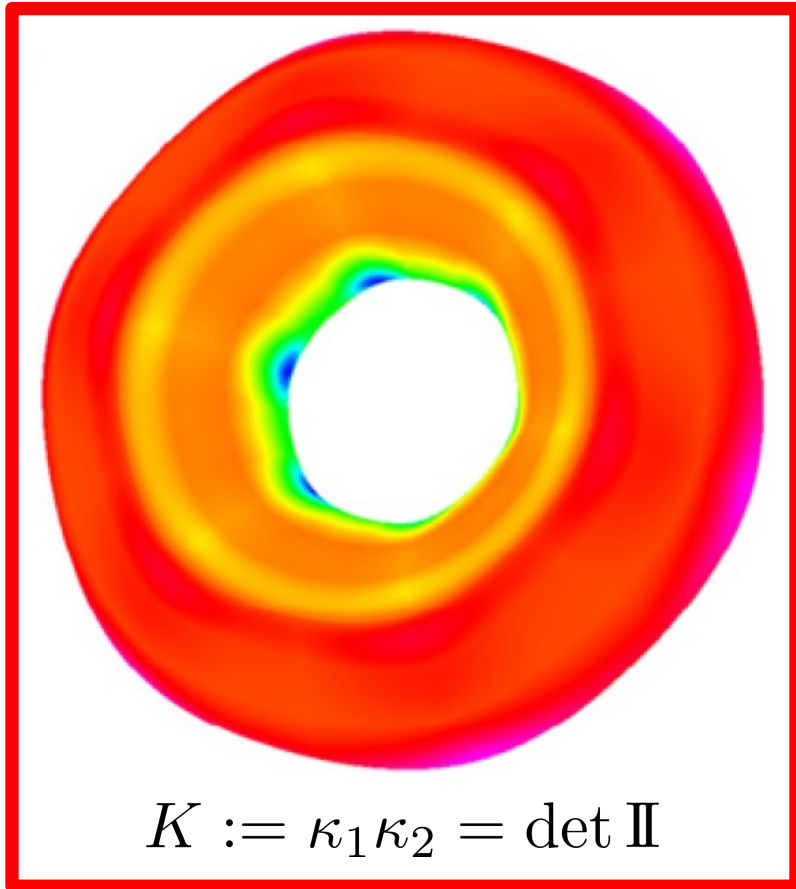

Theorema Egregium
 (“Totally Awesome
Theorem”):
Gaussian curvature is
intrinsic.

What is Distortion?

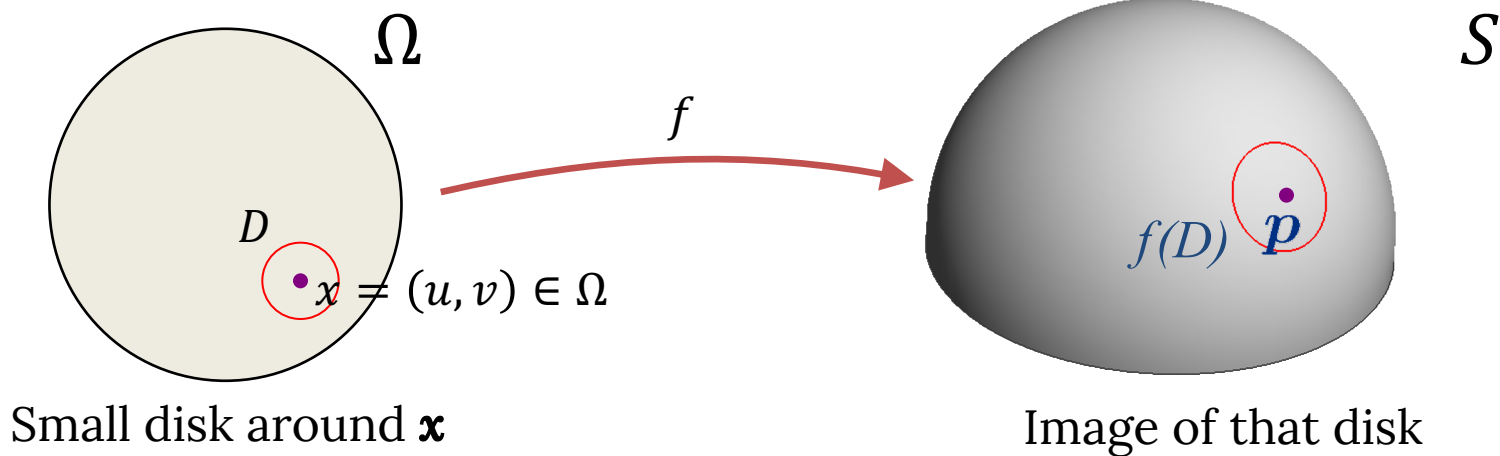

- Distortion (at x): How different is $f(D)$ from D
 - How to measure?

How to quantify distortion?
 Study **differential** / **Jacobian**.

$$f(y) = f(x) + \underbrace{\left(\frac{\partial f}{\partial x_i} \right)}_{\text{linearization } \tilde{f}(y)} (y - x) + O(\|y - x\|^2)$$

linearization $\tilde{f}(y)$

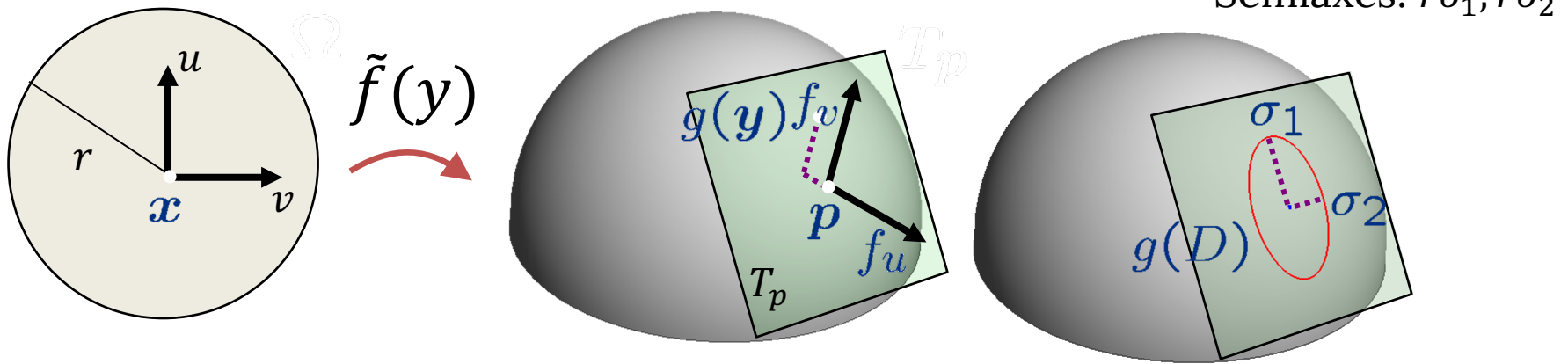

Linear Map Surgery

- **Singular Value Decomposition** (SVD) of J_f

$$J_f = U\Sigma V^T = U \begin{pmatrix} \sigma_1 & 0 \\ 0 & \sigma_2 \\ 0 & 0 \end{pmatrix} V^T$$

with **rotations** $U \in \mathbb{R}^{3 \times 3}$, $V \in \mathbb{R}^{2 \times 2}$
and **scale factors** (singular values) $\sigma_1, \sigma_2 \geq 0$

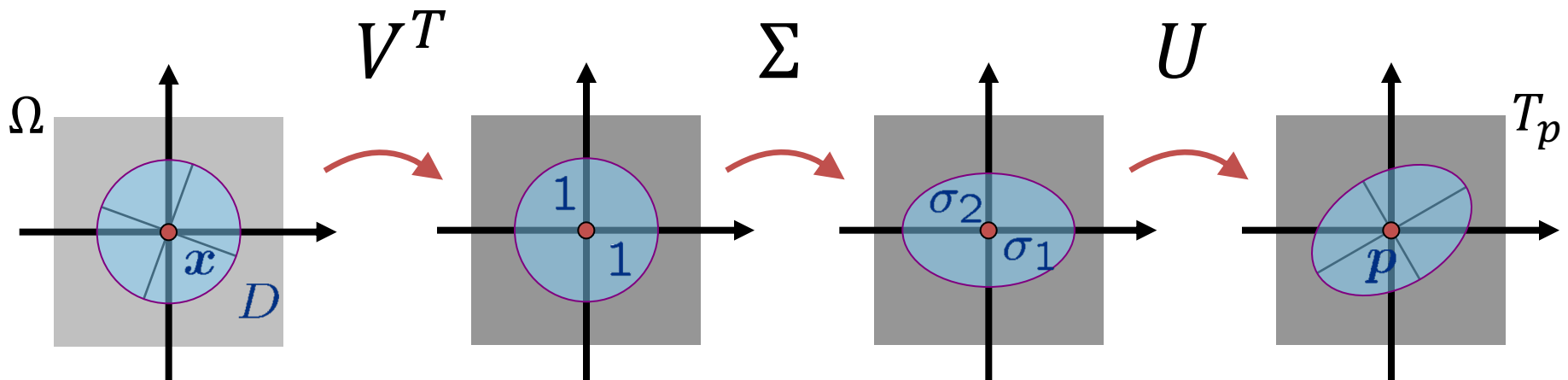

How to quantify distortion?
Study **Metric Tensor = 1st fundamental form.**

$$I = \begin{pmatrix} f_u \cdot f_u & f_u \cdot f_v \\ f_u \cdot f_v & f_v \cdot f_v \end{pmatrix}$$

How to quantify distortion?
Study **Metric Tensor = 1st fundamental form.**

$$I = \begin{pmatrix} f_u \cdot f_u & f_u \cdot f_v \\ f_u \cdot f_v & f_v \cdot f_v \end{pmatrix} \stackrel{\text{"Gram Matrix"}}{=} J_f^T J_f$$

How to quantify distortion?
Study **Metric Tensor = 1st fundamental form.**

$$I = \begin{pmatrix} f_u \cdot f_u & f_u \cdot f_v \\ f_u \cdot f_v & f_v \cdot f_v \end{pmatrix} = J_f^T J_f$$

$$= (U\Sigma V^T)^T (U\Sigma V^T) = V \begin{pmatrix} \sigma_1^2 & 0 \\ 0 & \sigma_2^2 \end{pmatrix} V^T$$

Eigenvalues of I

Pointwise distortion

Isometric

$$\sigma_1 = \sigma_2 = 1$$

Conformal or **angle**-preserving

$$\sigma_1 = \sigma_2$$

Equiareal or **area**-preserving

$$\sigma_1 \cdot \sigma_2 = 1$$

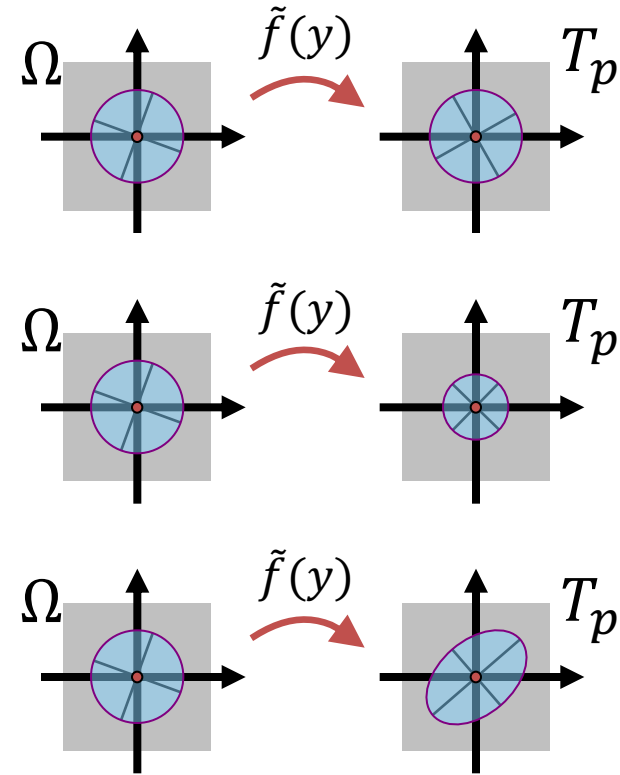

Defined pointwise on Ω

Measuring Distortion

- **Local** distortion measure function of σ_1 and σ_2

$$E: (\mathbb{R}_+ \times \mathbb{R}_+) \rightarrow \mathbb{R}, \quad (\sigma_1, \sigma_2) \mapsto E(\sigma_1, \sigma_2)$$

- **Overall** distortion

$$E(f) = \int_{\Omega} E(\sigma_1(u, v), \sigma_2(u, v)) du dv / \text{Area}(\Omega)$$

- On mesh constant per triangle

$$E(f) = \sum_{t \in \Omega} E(t) A(t) / \sum_{t \in \Omega} A(t)$$

CONFORMAL MAPS

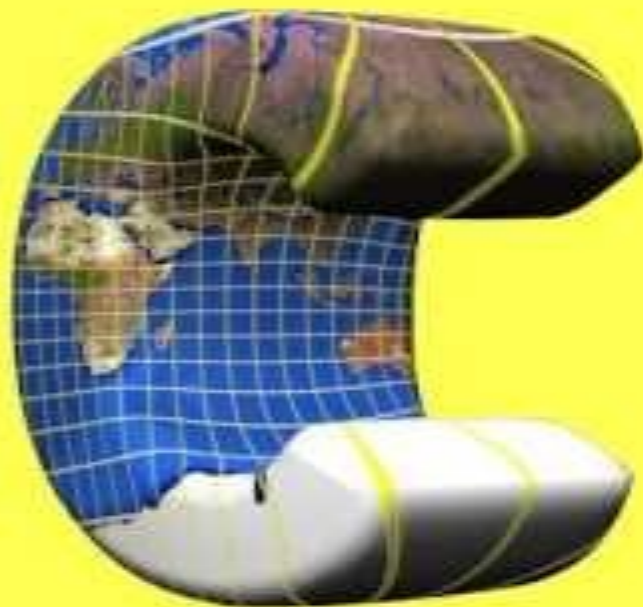

Stereographic Projection

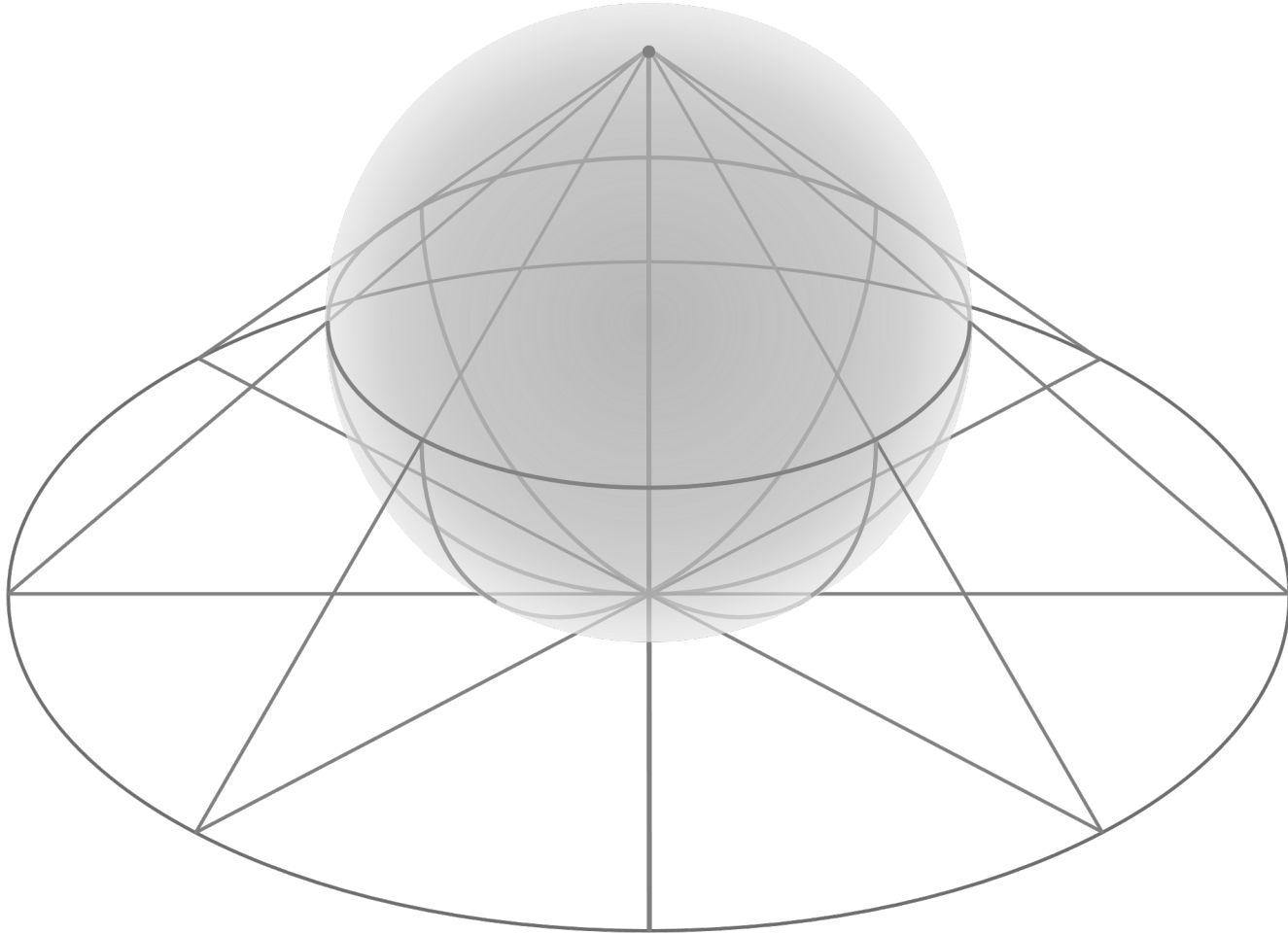
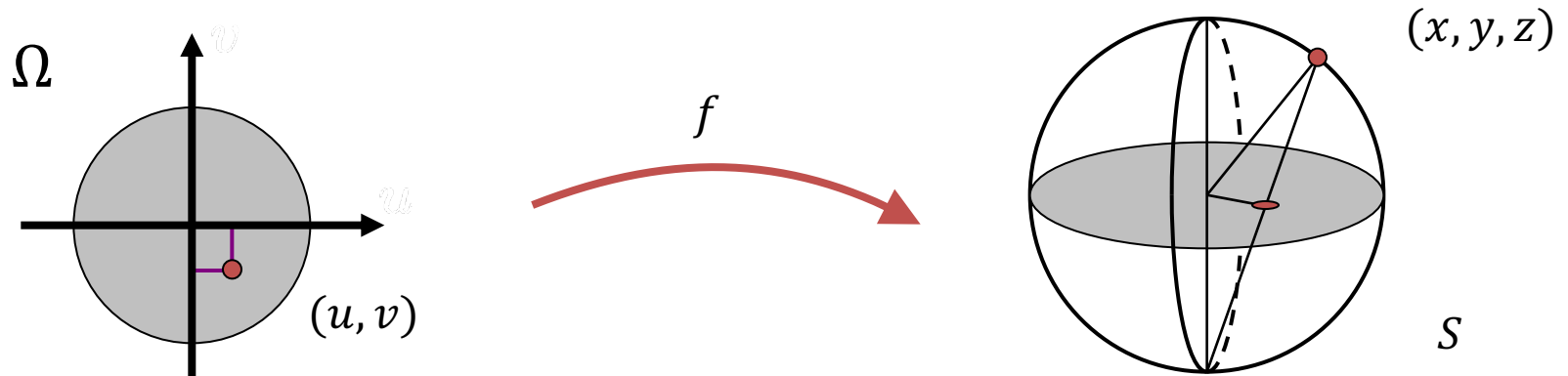

Image from Wikipedia

Stereographic Projection



parameterization: $f(u, v) = (2ud, 2vd, (1 - u^2 - v^2)d)$ with $d = \frac{1}{1+u^2+v^2}$

Jacobian: $J_f = \begin{pmatrix} 2d-4u^2d^2 & -4uvd^2 \\ -4uvd^2 & 2d-4v^2d^2 \\ -4ud^2 & -4vd^2 \end{pmatrix}$

first fundamental form: $\mathbf{I}_f = \begin{pmatrix} 4d^2 & 0 \\ 0 & 4d^2 \end{pmatrix}$

eigenvalues: $\lambda_1 = 4d^2, \quad \lambda_2 = 4d^2$

$\sigma_1 = \sigma_2 = 2d \quad \Rightarrow \quad \text{conformal}$

Stereographic Projection

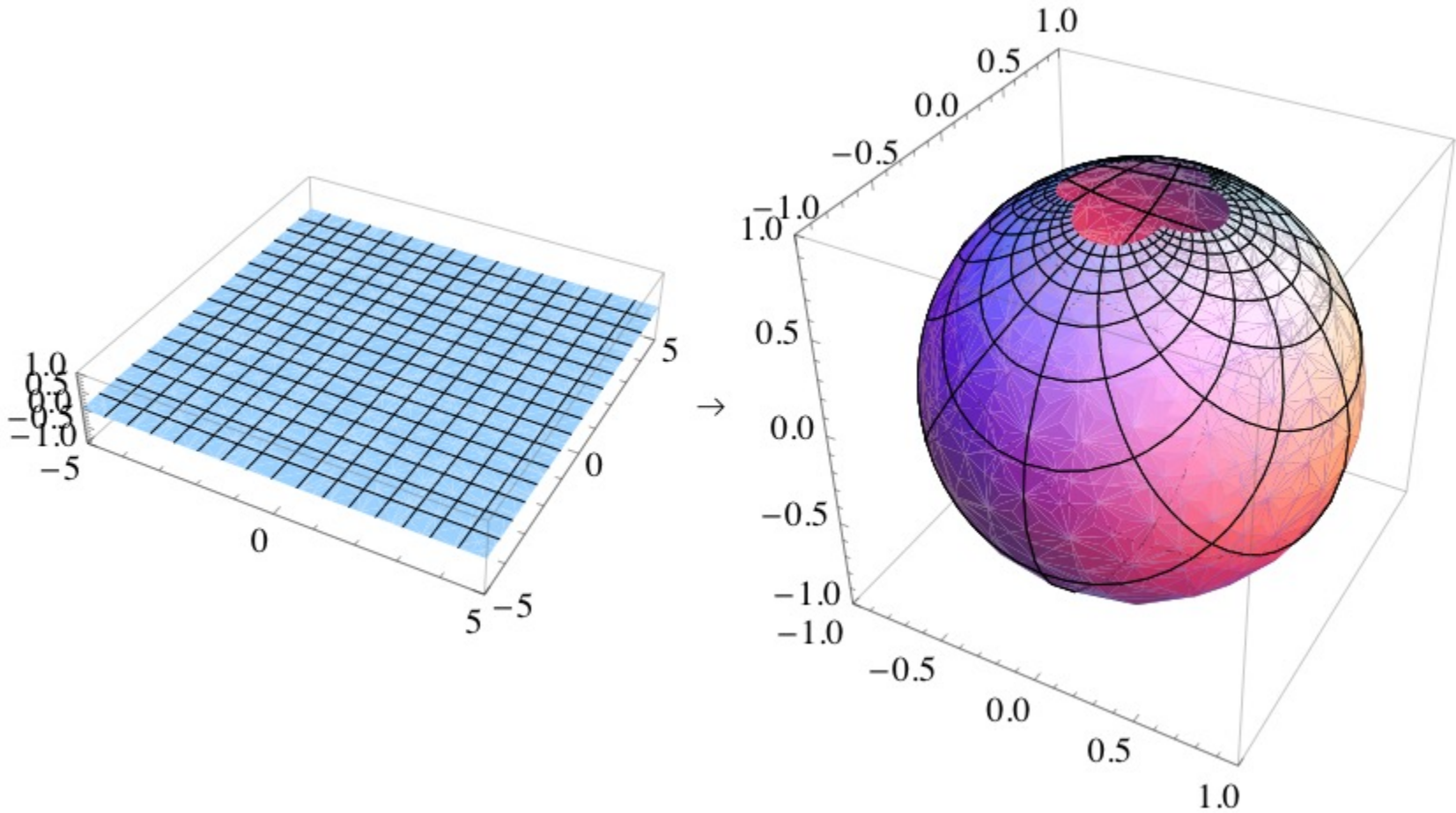

Image from Wikipedia

Stereographic Projection



Does conformal map exist?

Uniformization theorem

“Every simply connected Riemann surface is conformally equivalent to one of three Riemann surfaces:

1. open unit disk
2. complex plane
3. Riemann sphere”

Parameterization: Practice

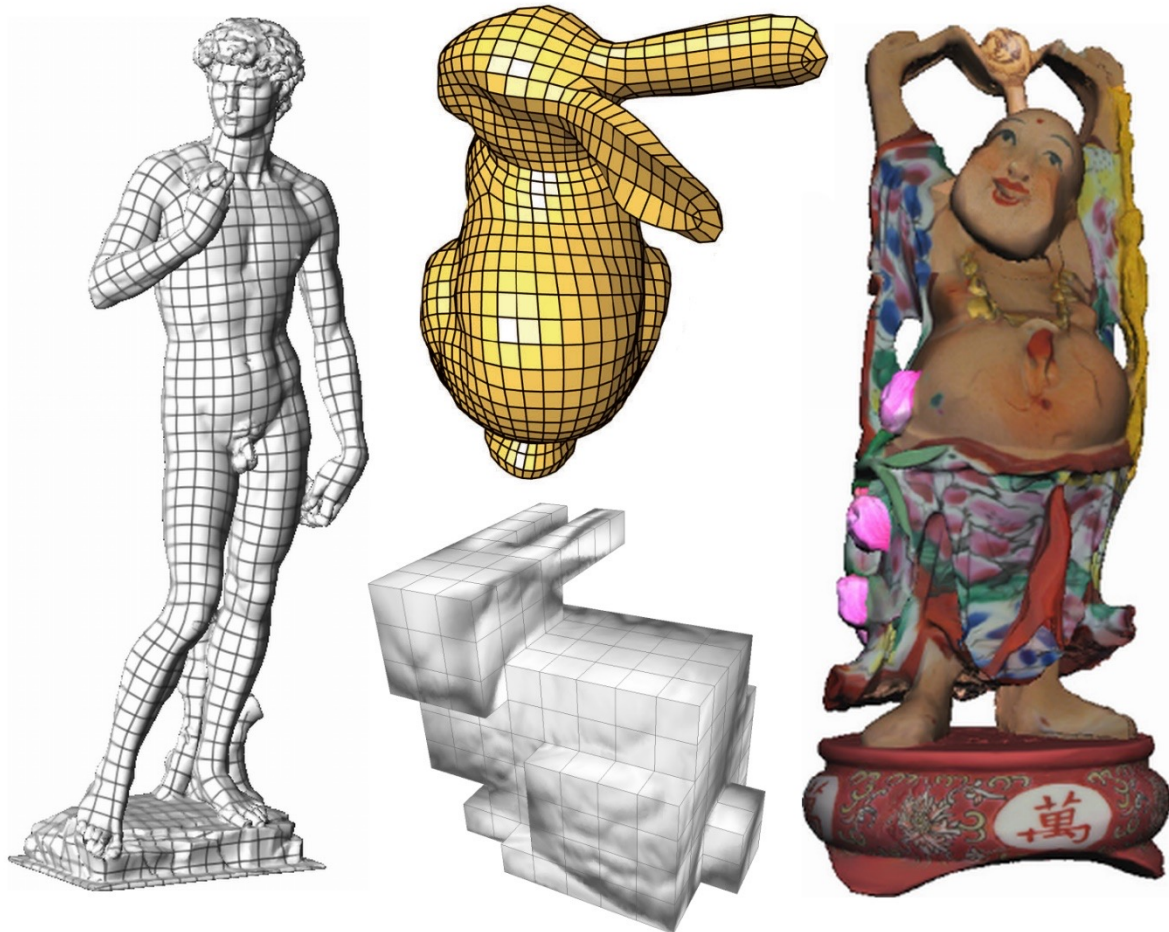

MESH PARAMETERIZATION METHODS

Fixed Boundary

Bijection: easy

Distortion: may be large

Free boundary

Bijection: hard

Distortion: minimum

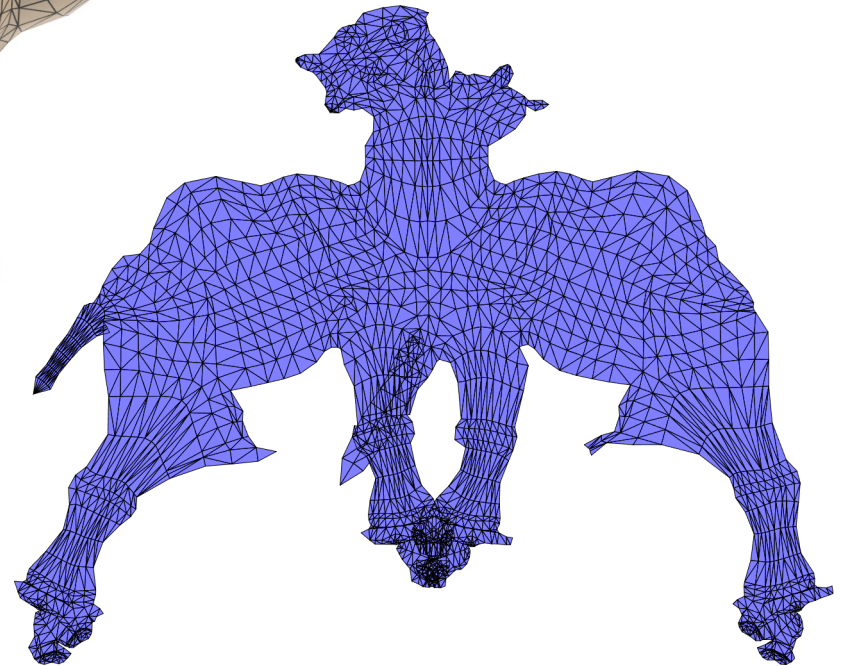
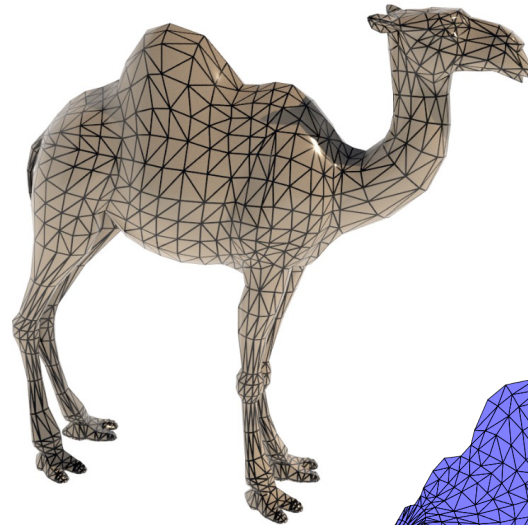
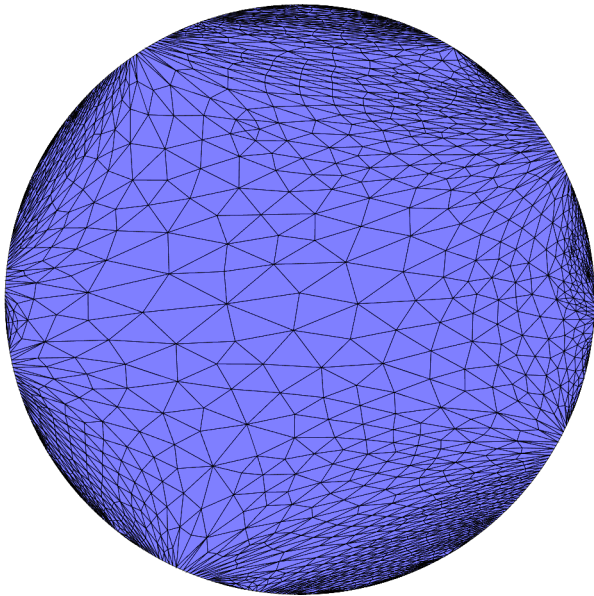

MESH PARAMETERIZATION METHODS

Fixed Boundary

Bijection: easy

Distortion: may be large

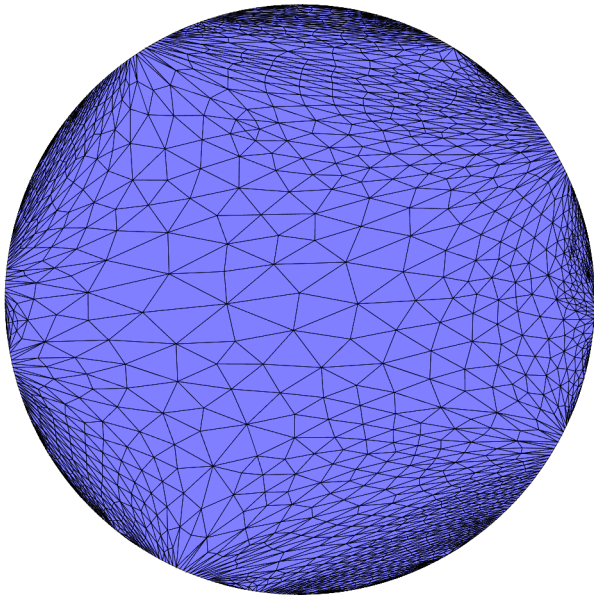

Free boundary

Bijection: hard

Distortion: minimum

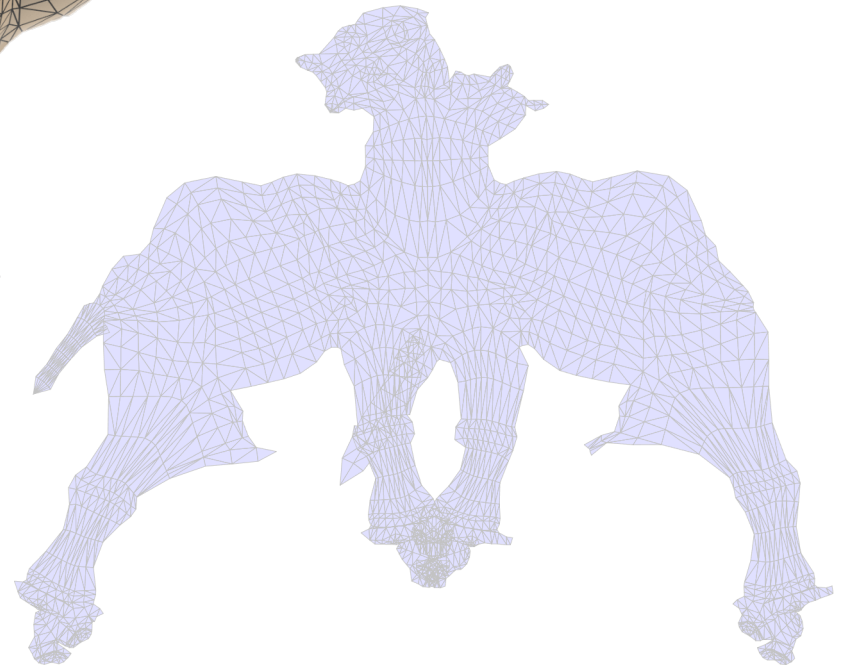
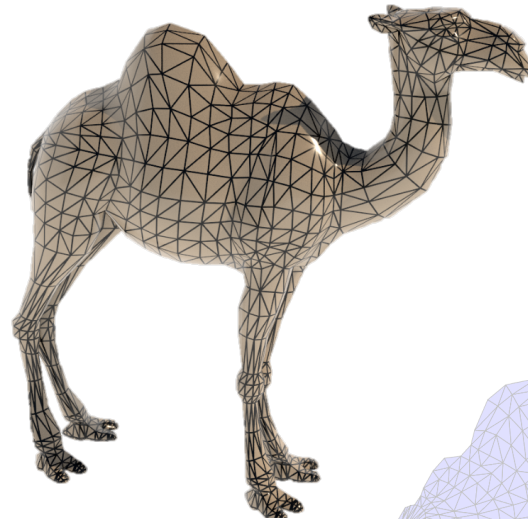

Spring Model

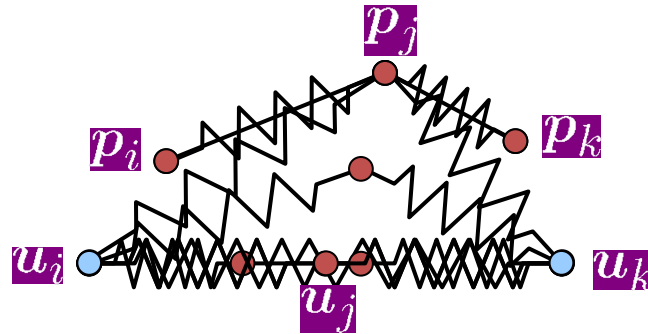

- Fix boundary vertices on **a convex** polygon
 - Edges \rightarrow springs
 - Let go of the springs
 - “Relaxation”

Spring Model

Hooke's Law:

Energy of spring between p_i and p_j

$$E_{ij} = 0.5 D_{ij} \|u_i - u_j\|_2^2$$

Total energy

$$E = \sum_{(i,j) \in E} \frac{1}{2} D_{ij} \|u_i - u_j\|_2^2$$

Spring Model

Hooke's Law:

Energy of spring between p_i and p_j

Will this provide a
bijection
parameterization?

Total energy

$$E = \sum_{(i,j) \in E} \frac{1}{2} D_{ij} \|u_i - u_j\|^2$$

Spring Model

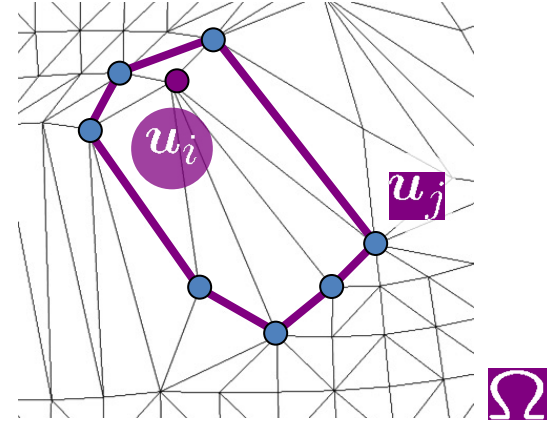
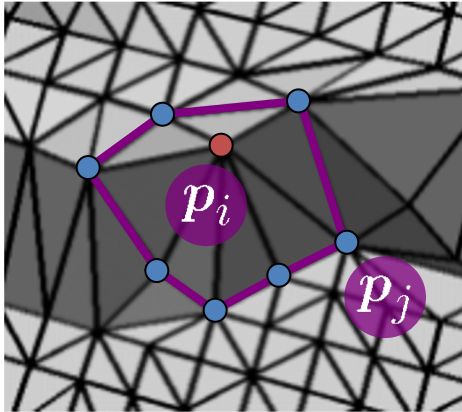

$$E = \sum_{(i,j) \in E} \frac{1}{2} D_{ij} \|u_i - u_j\|^2 = \frac{1}{2} \sum_{i=1}^n \sum_{j \in N_i} \frac{1}{2} D_{ij} \|u_i - u_j\|^2$$

Spring Model

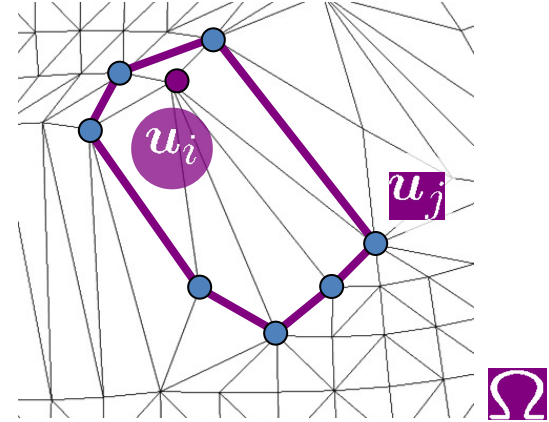
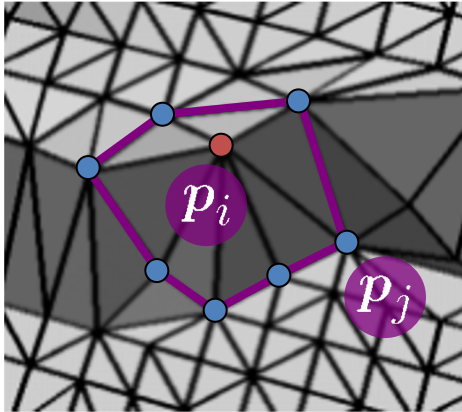

$$E = \frac{1}{2} \sum_{i=1}^n \sum_{j \in N_i} \frac{1}{2} D_{ij} \|u_i - u_j\|^2$$

Stable state \Leftrightarrow minimum of total energy

Spring Model

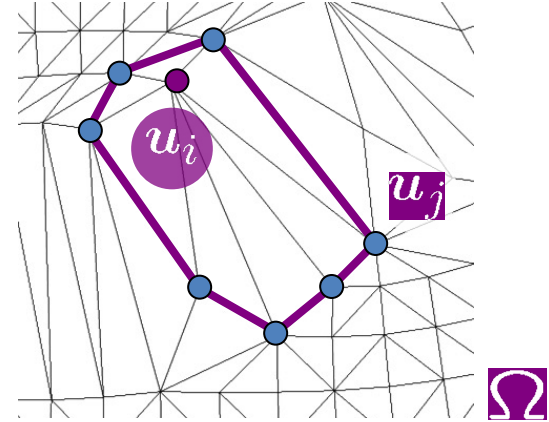
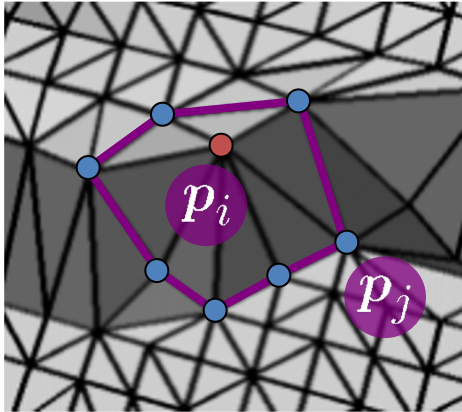

$$E = \frac{1}{2} \sum_{i=1}^n \sum_{j \in N_i} \frac{1}{2} D_{ij} \|u_i - u_j\|^2$$

Stable state \Leftrightarrow minimum of total energy

$$\frac{\partial E}{\partial u_i} = \sum_{j \in N_i} D_{ij} (u_i - u_j) = 0$$

Spring Model

$$E = \frac{1}{2} \sum_{i=1}^n \sum_{j \in N_i} \frac{1}{2} D_{ij} \|u_i - u_j\|^2$$

$$\sum_{j \in N_i} D_{ij} (u_i - u_j) = 0$$

Rewrite:

$$u_i = \sum_{j \in N_i} \lambda_{ij} u_j \qquad \lambda_{ij} = D_{ij} / \sum_{k \in N_i} D_{ik}$$

Spring Model

$$E = \frac{1}{2} \sum_{i=1}^n \sum_{j \in N_i} \frac{1}{2} D_{ij} \|u_i - u_j\|^2$$

$$\sum_{j \in N_i} D_{ij} (u_i - u_j) = 0$$

Rewrite:

$$u_i = \sum_{j \in N_i} \lambda_{ij} u_j \quad \lambda_{ij} = D_{ij} / \sum_{k \in N_i} D_{ik}$$

A generalization of
barycentric coordinates

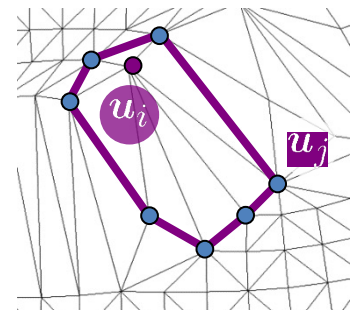

Linear System

- Let's rearrange the variables:

$$u_i - \underbrace{\sum_{j \in N_i, j \leq n} \lambda_{ij} u_j}_{\text{unknown parameter points}} = \underbrace{\sum_{j \in N_i, j > n} \lambda_{ij} u_j}_{\text{fixed}} = \bar{u}_i$$

- Linear system

$$AU = \bar{U},$$

$$A = \begin{cases} 1, & i = j \\ -\lambda_{ij}, & j \in N_i \\ 0, & \text{else} \end{cases}$$

$$\lambda_{ij} = D_{ij} / \sum_{k \in N_i} D_{ik}$$

- Solve separately for u and v

Linear System

- Let's rearrange the variables:

$$u_i - \underbrace{\sum_{j \in N_i, j \leq n} \lambda_{ij} u_j}_{\text{unknown parameter points}} = \underbrace{\sum_{j \in N_i, j > n} \lambda_{ij} u_j}_{\text{fixed}} = \bar{u}_i$$

- Linear system

$$AU = \bar{U},$$

$$A = \begin{cases} 1, & i = j \\ -\lambda_{ij}, & j \in N_i \\ 0, & \text{else} \end{cases}$$

$$\lambda_{ij} = D_{ij} / \sum_{k \in N_i} D_{ik}$$

What does the matrix remind you of?

- Solve separately for u and v

Theorem [Tutte'63,Floater'01,Maxwel'1864]:

If G is a 3-connected planar graph (*triangular mesh*) then any convex combination embedding ($\lambda_{ij} > 0$) provides bijective parameterization

Choice of Weights: Uniform (Tutte)

$$D_{ij} = 1 \qquad \lambda_{ij} = \frac{1}{\#N_i}$$

No shape preservation – equilateral triangles

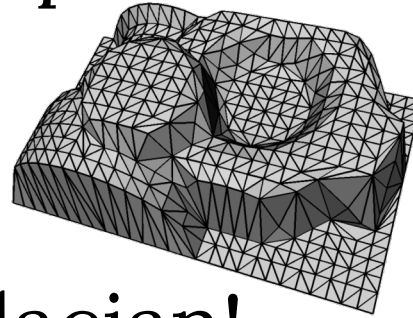
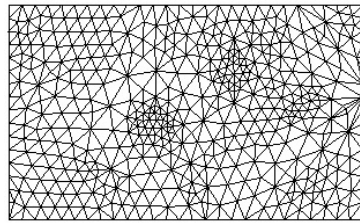

Graph Laplacian!

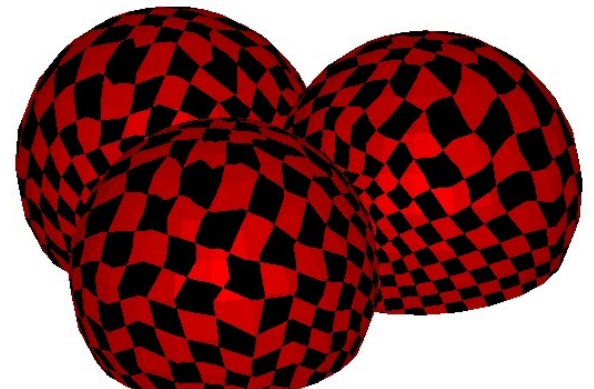
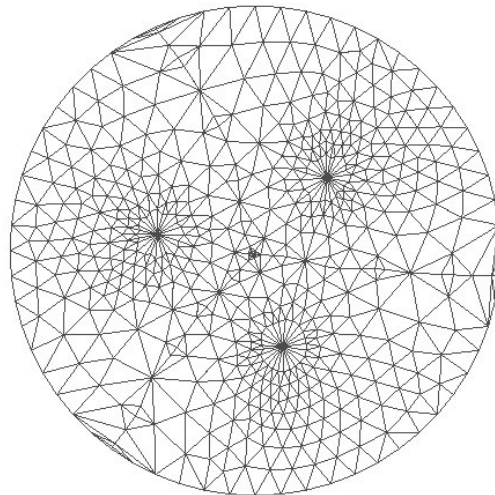
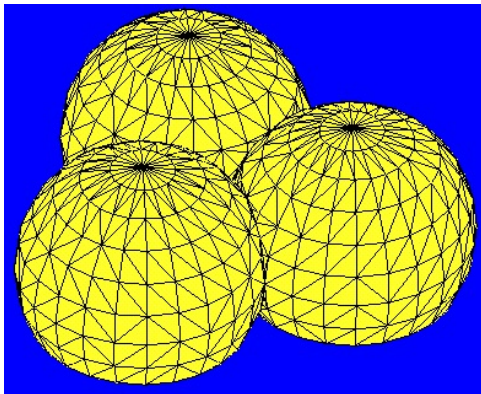

Choice of Weights: Uniform (Tutte)

$$D_{ij} = 1 \qquad \lambda_{ij} = \frac{1}{\#N_i}$$

No shape preservation – equilateral triangles

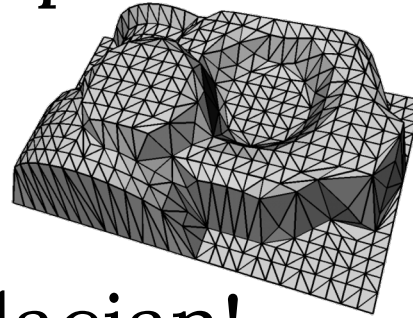
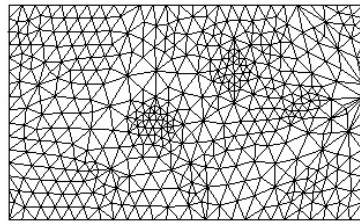

Graph Laplacian!

$$E = \sum_{(i,j) \in E} \frac{1}{2} D_{ij} \|u_i - u_j\|^2 \text{ is}$$

Dirichlet energy discretized on a graph!

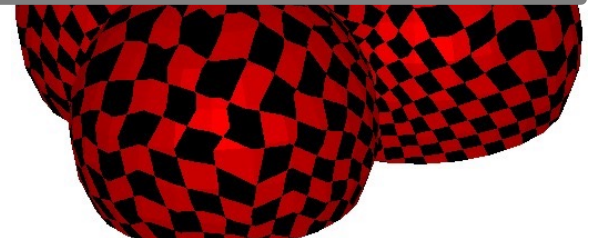
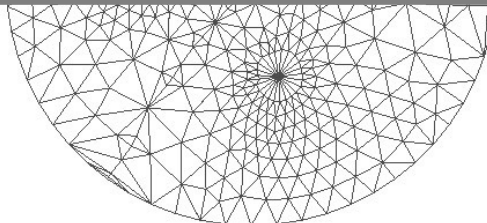
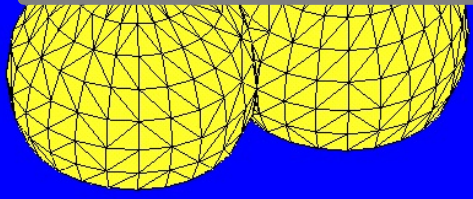

Choice of Weights: Barycentric Harmonic/Conformal/FEM Laplacian

$$\omega_{ij} = \cot\gamma_{ij} + \cot\gamma_{ji}$$

$$\lambda_{ij} = \omega_{ij} / \sum_k \omega_{ik}$$

$$E = \sum_{(i,j) \in E} \frac{1}{2} D_{ij} \|u_i - u_j\|^2 \text{ is}$$

Dirichlet energy discretized on a mesh!

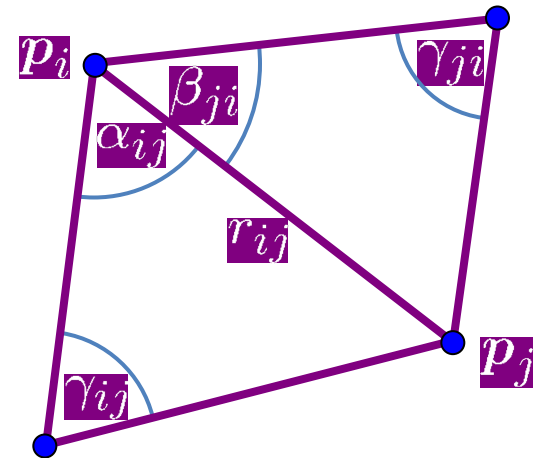

Issue

Point is inside, but the coordinate can be <0

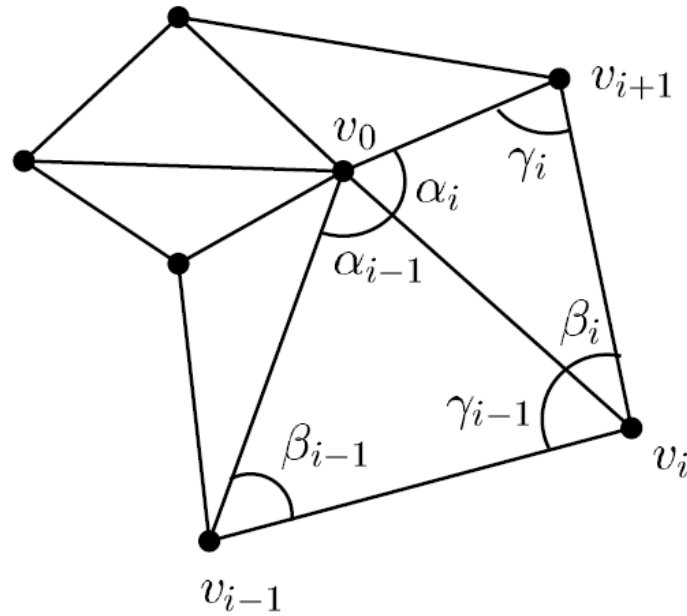

Figure 1. Star-shaped polygon.

Issue

Point is inside, but the coordinate can be < 0

$$\Rightarrow \exists \lambda_{ij} < 0$$

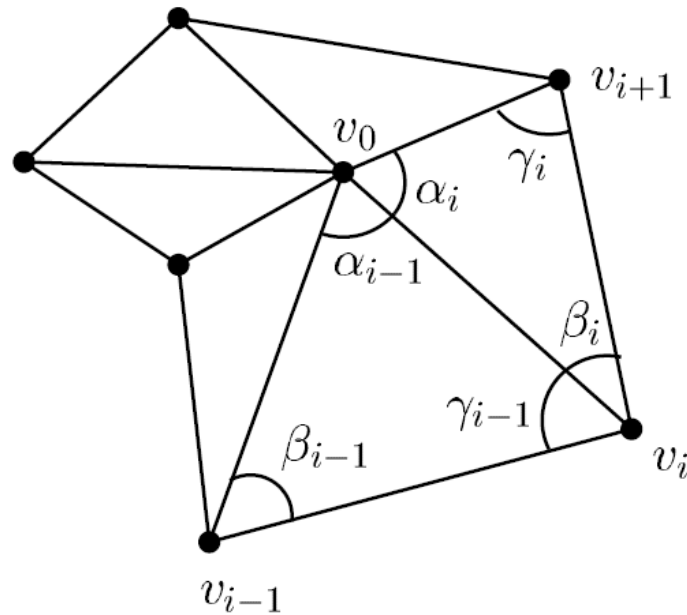

Figure 1. Star-shaped polygon.

Issue

Point is inside, but the coordinate can be < 0
 $\Rightarrow \exists \lambda_{ij} < 0$

Local non-bijectivity

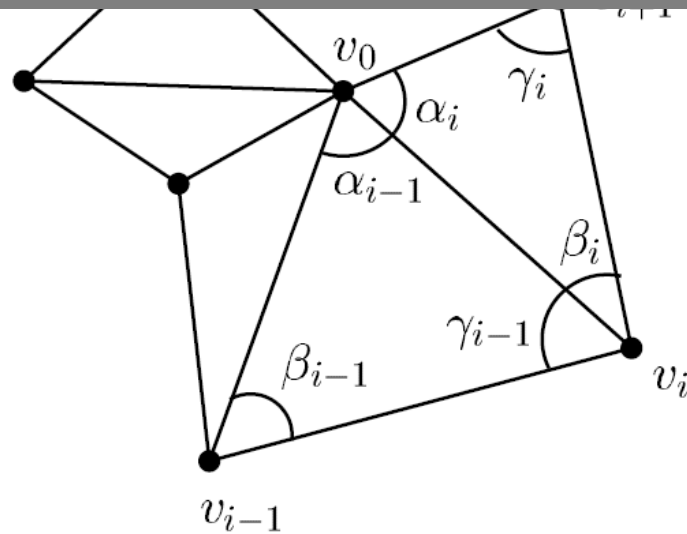
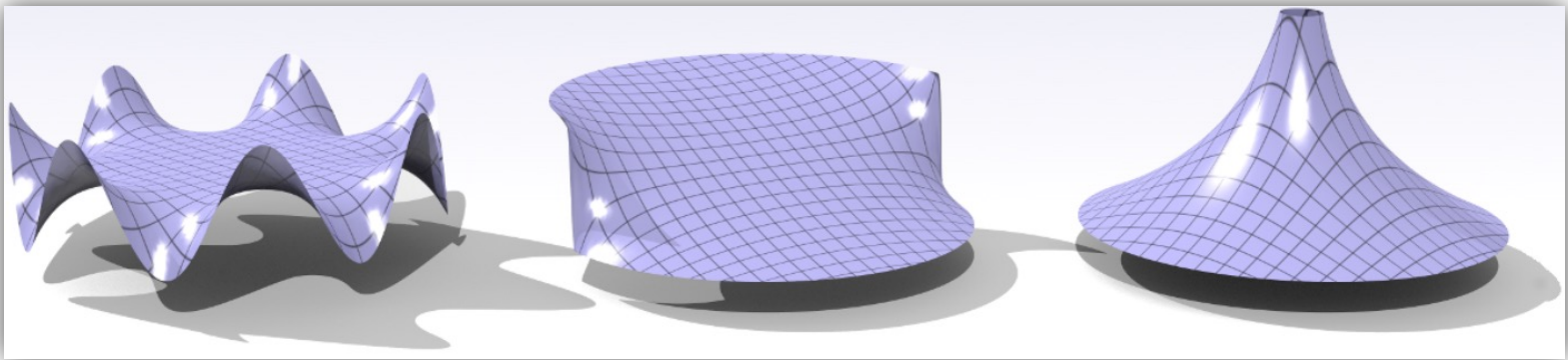

Figure 1. Star-shaped polygon.

Recall:

Harmonic Functions

$$\Delta f \equiv 0$$



Mean value property:

$$f(x) = \frac{1}{\pi r^2} \int_{B_r(x)} f(y) dA$$

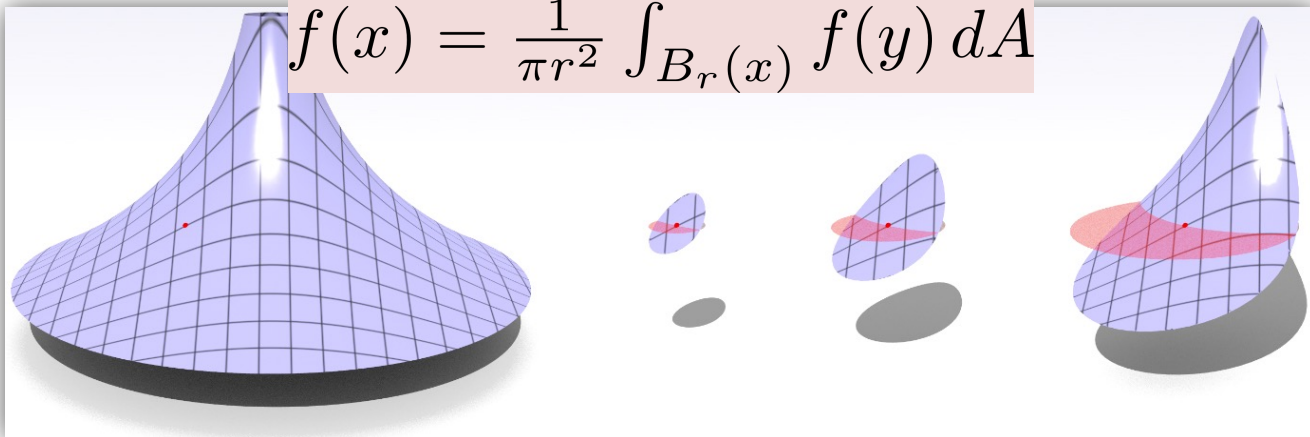

Choice of Weights: Mean Value

$$\omega_{ij} = \frac{\tan \frac{\alpha_{ij}}{2} + \tan \frac{\beta_{ji}}{2}}{r_{ij}}$$

$$\lambda_{ij} = \frac{\omega_{ij}}{\sum_{k \in N_i} \omega_{ik}}$$

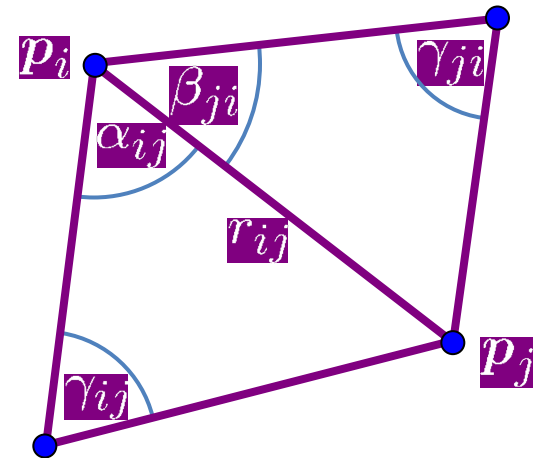

Choice of Weights: Mean Value

$$\omega_{ij} = \frac{\tan \frac{\alpha_{ij}}{2} + \tan \frac{\beta_{ji}}{2}}{r_{ij}}$$

Always non-negative

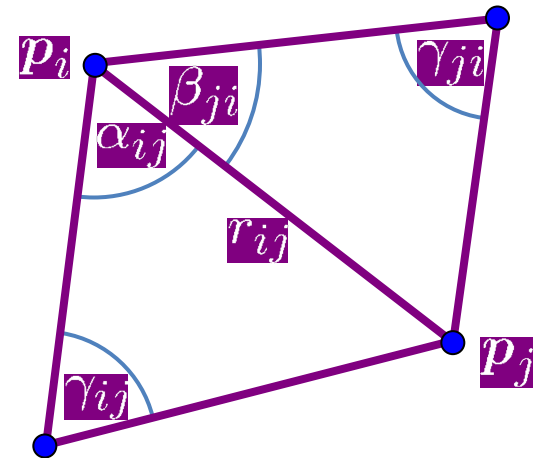

Harmonic/Mean-Value Mappings

- Quasi-Conformal

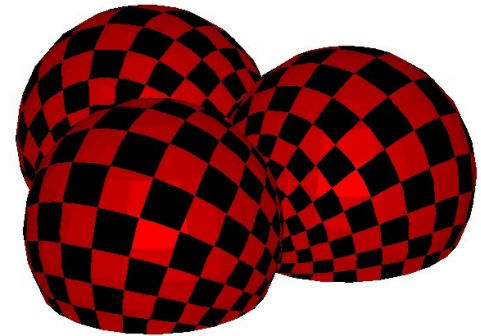
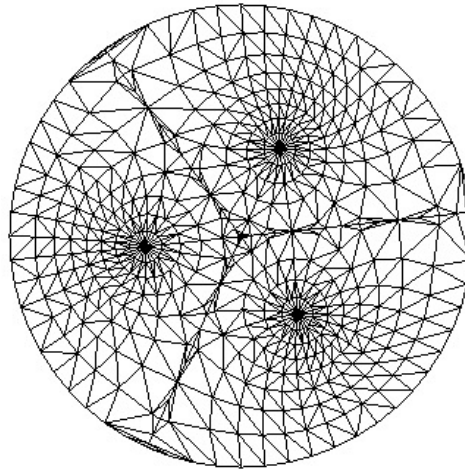
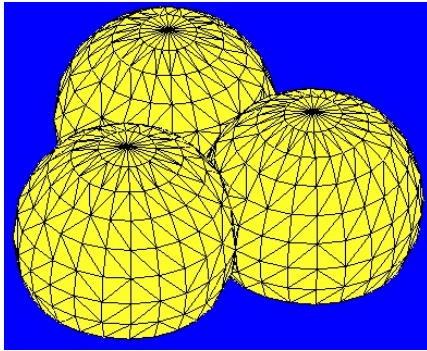

- Linear precision
 - Reproduce planar inputs (same boundary)

Bijection (fold-overs)

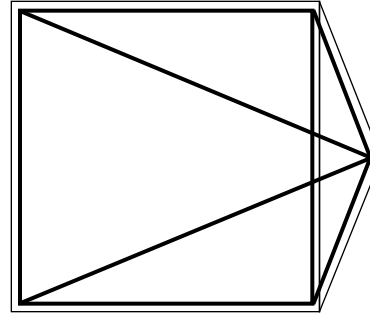
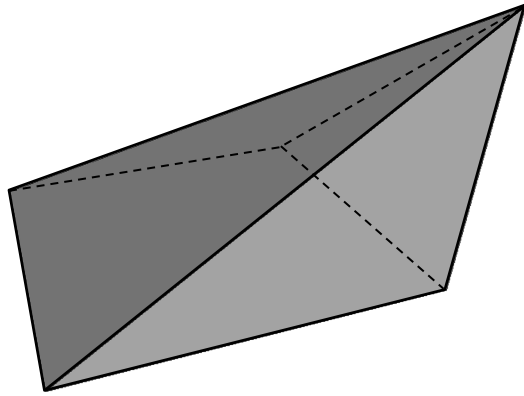

harmonic

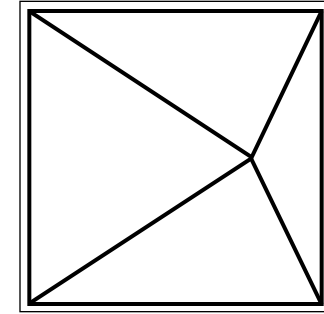

mean value

- Can have fold-overs for negative coordinates
- Mean-value coordinates guaranteed to be positive

$$\lambda_{ij} = \frac{w_{ij}}{\sum_{k \in N_i} w_{ik}}$$

Boundary Mapping

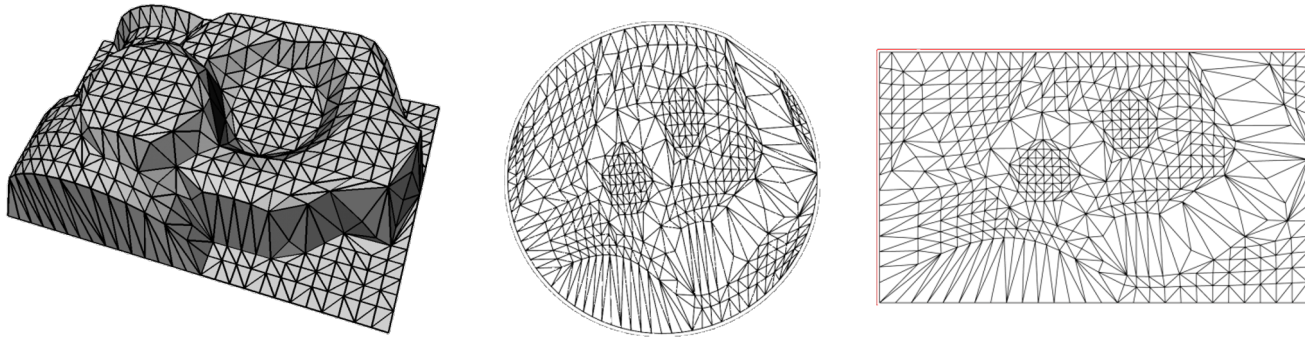

Chordal parameterization around **convex** shape

- circle
- rectangle
- triangle
- Choice often application specific
 - Reconstruction – rectangle
 - Mapping to base mesh – triangle

Examples

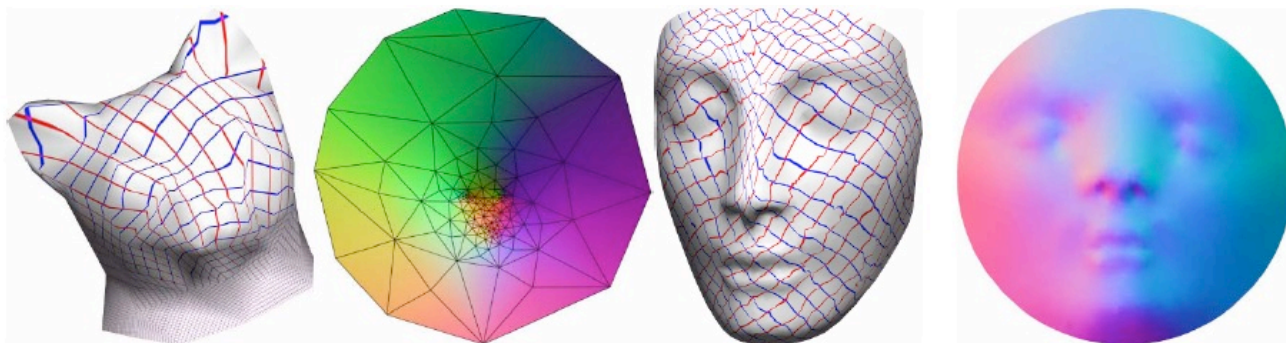

Parameterization with uniform weights [Tutte 1963] on a circular domain.

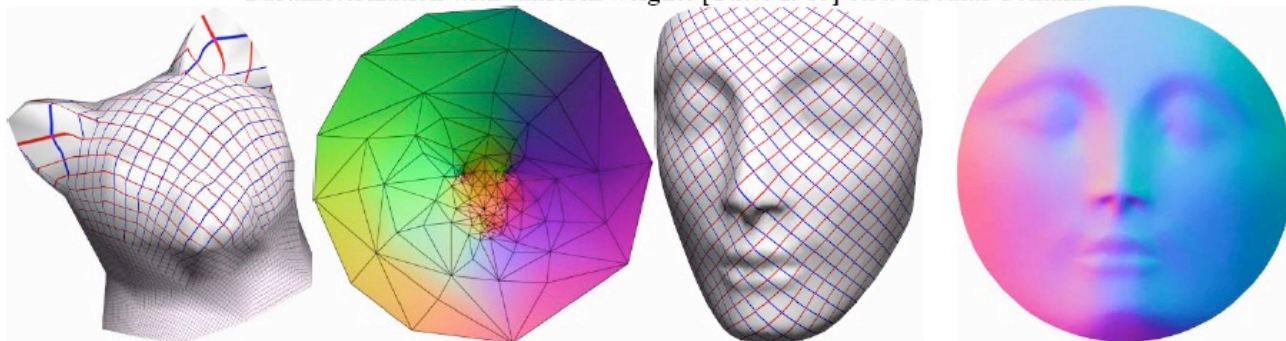

Parameterization with harmonic weights [Eck et al. 1995] on a circular domain.

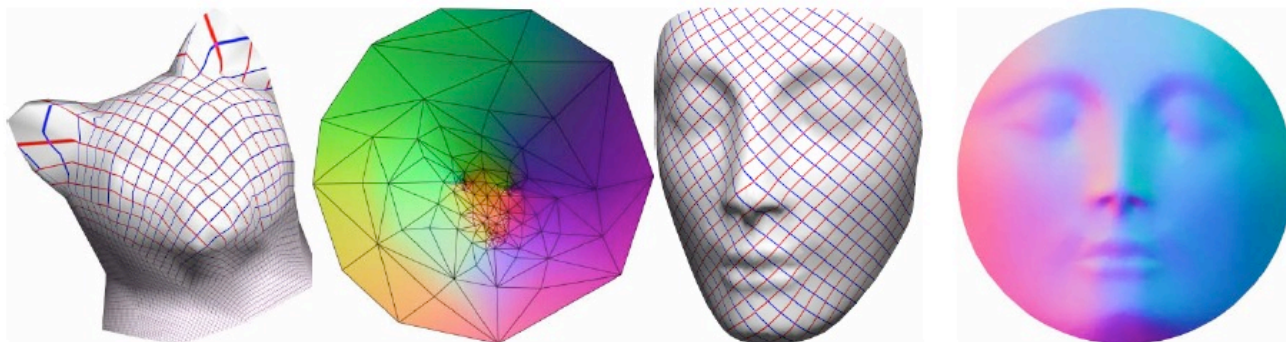

Parameterization with mean value weights [Floater 2003] on a circular domain.

Parameterization: Free Boundary

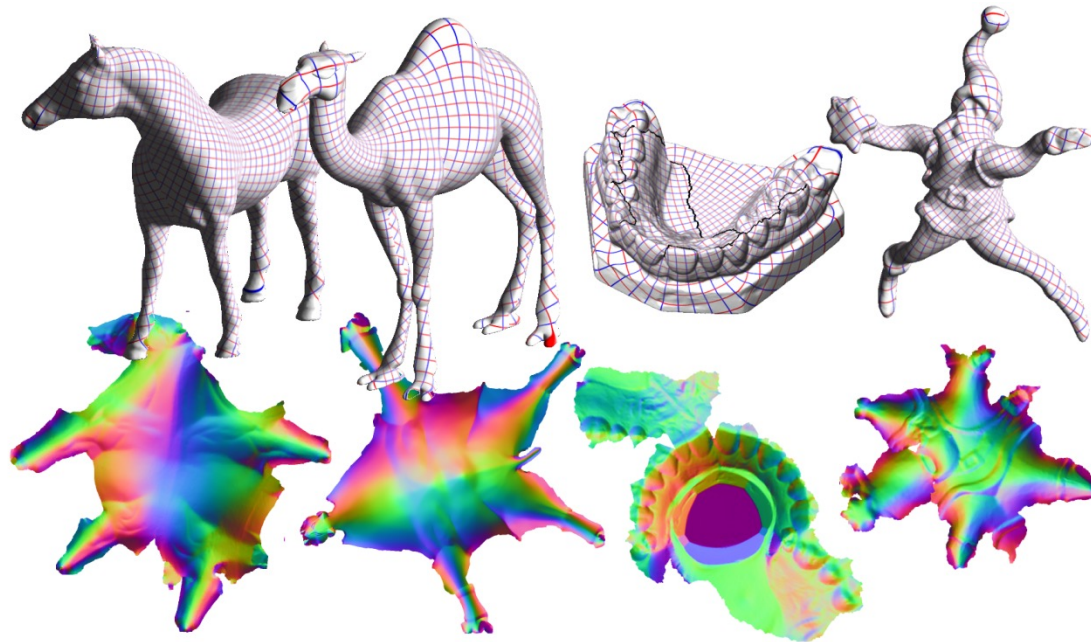

Free Boundary Methods

- Direct energy minimization
 - Example: Least Squares Conformal Map (LSCM)....
- Indirect
 - Example: Angle Based Flattening (ABF)....

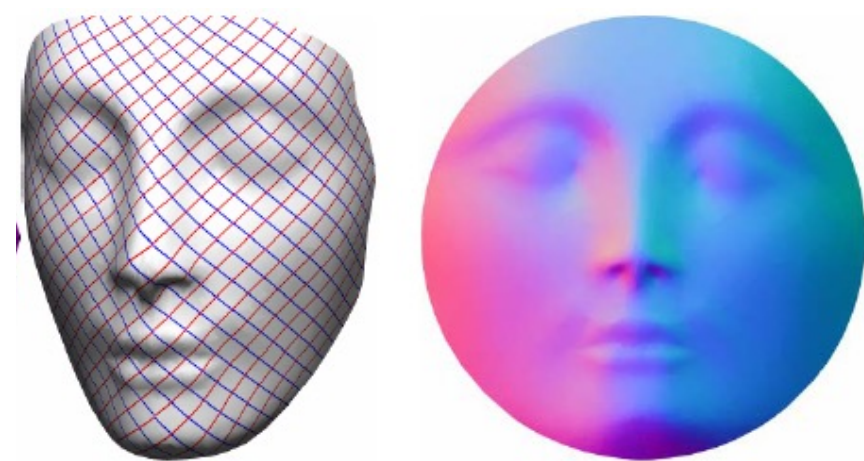

Flattening [Floater 2003] on a circular domain.

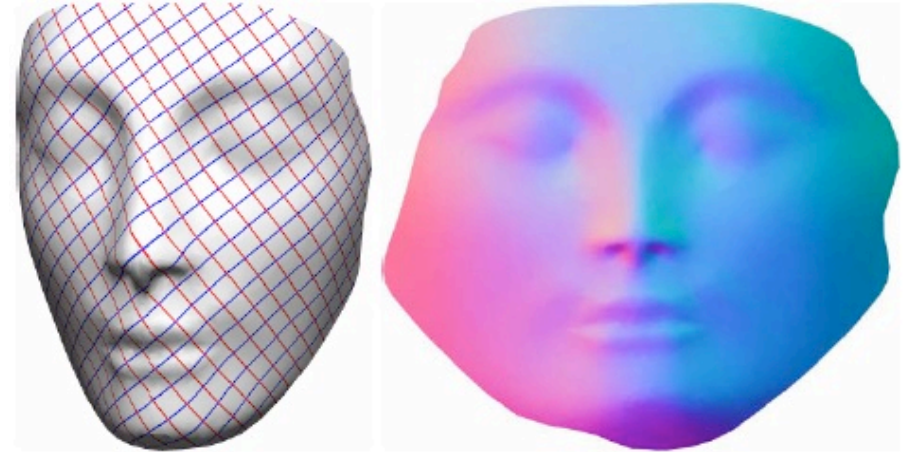

LSCM [Lévy et al. 2002].

Free vs Fixed

LSCM – Geometric Interpretation

We're minimizing conformal energy

$$E_C = (\sigma_1 - \sigma_2)^2 / 2$$

Geometric Interpretation:

- Use triangle similarity
- Given angles $\alpha_1, \alpha_2, \alpha_3$ of a triangle $P_1P_2P_3$ in 2D we have

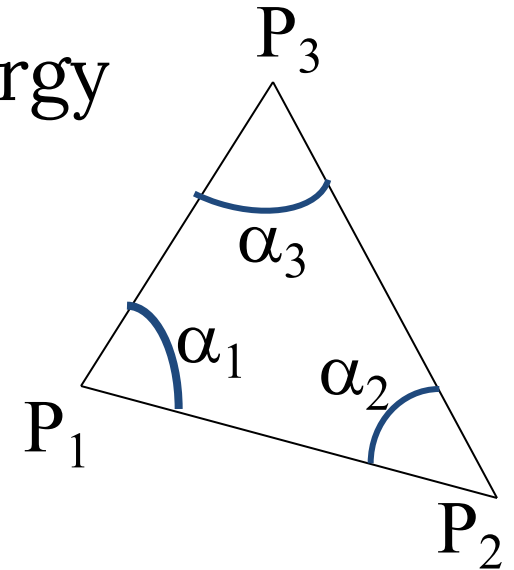

$$P_3 - P_1 = \frac{\sin \alpha_2}{\sin \alpha_3} R_{\alpha_1} (P_2 - P_1),$$

$$R_\alpha = \begin{pmatrix} \cos \alpha & \sin \alpha \\ -\sin \alpha & \cos \alpha \end{pmatrix}$$

LSCM

- In map from 3D to 2D might be impossible to keep angles exactly
 - Use least-squares

$$\min \sum_i (P_3^i - P_1^i - \frac{\sin \alpha_2^i}{\sin \alpha_3^i} R_{\alpha_1^i} (P_2^i - P_1^i))^2$$

- To solve need to fix two vertices
 - Obtain linear system
 - Choice of vertices affects solution
- Can have flips

Examples

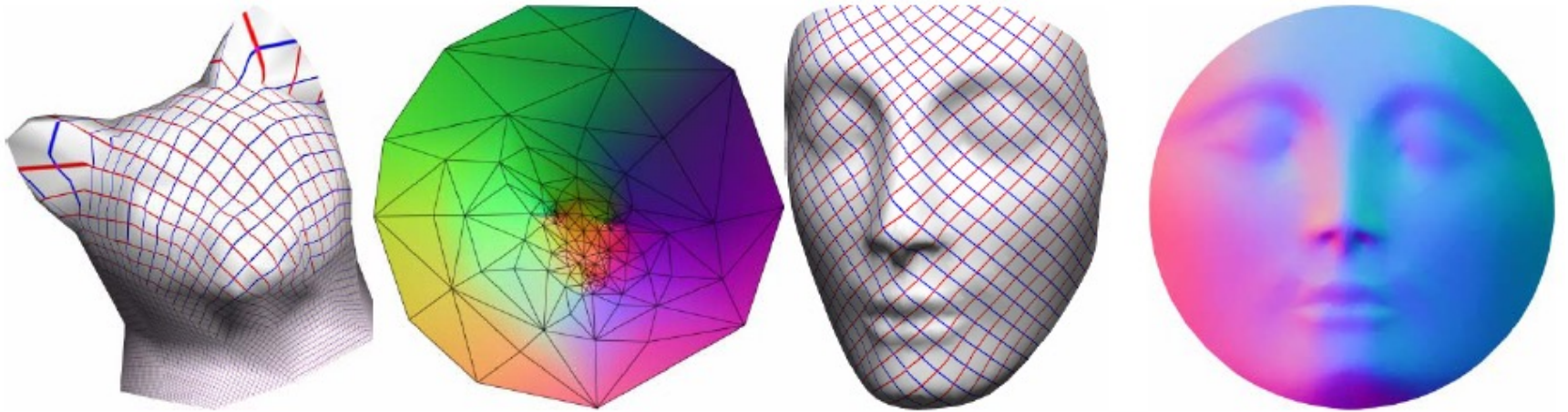

Parameterization with mean value weights [Floater 2003] on a circular domain.

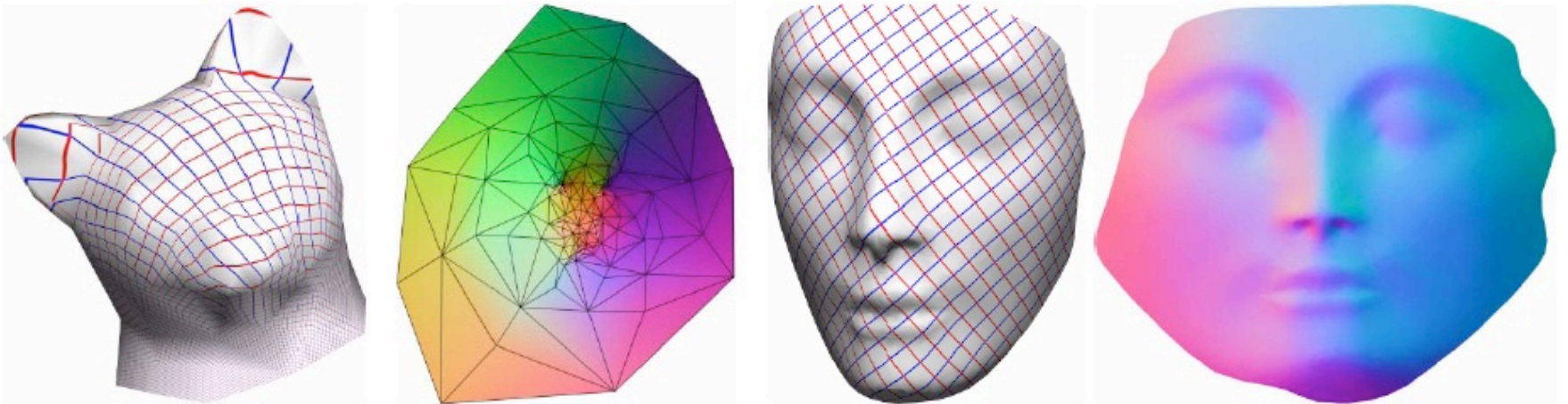

Parameterization with LSCM [Lévy et al. 2002].

ABF: Angle Based Flattening

- Triangular 2D mesh is defined by its angles
- Formulate parameterization as problem in angle space
- Angle based formulation:
 - Distortion as function of angles (conformality)
 - Validity: set of angle constraints
 - Convert solution to UV

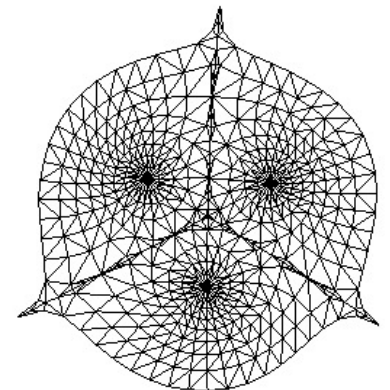
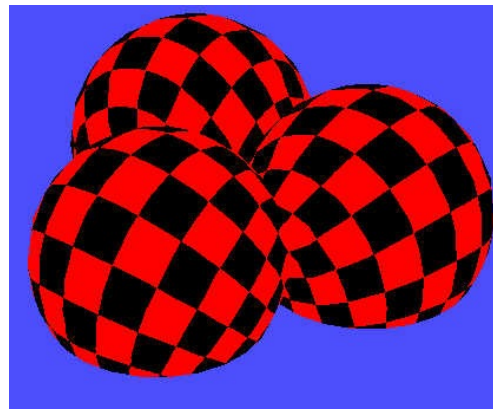

ABF Formulation

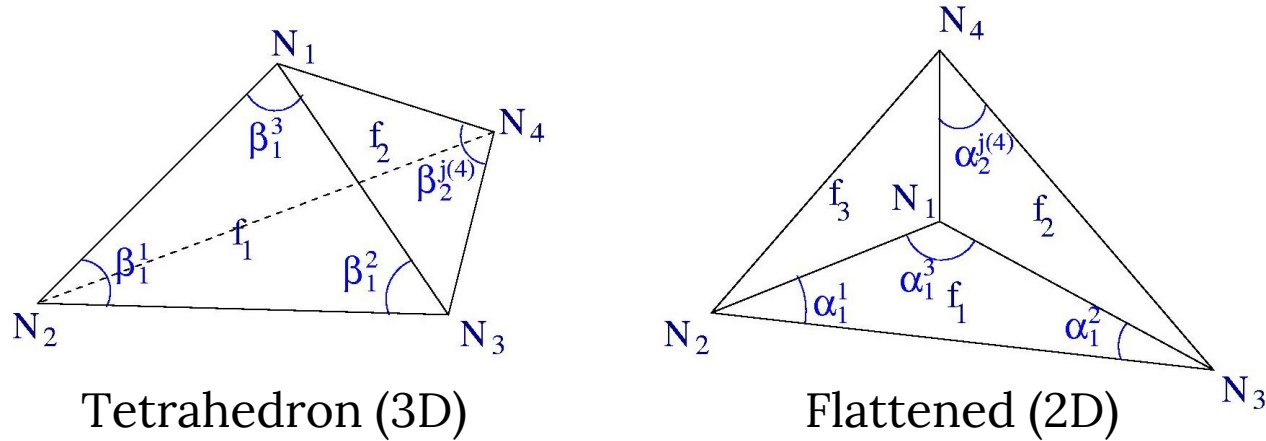

- Distortion:
 - 2D/3D angle difference

$$\sum_{t \in T, j=1 \dots 3} w_j^t (\alpha_j^t - \beta_j^t)^2, w_j^t = 1/\beta_j^{t^2}$$

ABF Formulation

- **Constraints:**

- Triangle validity:

$$\forall t \in T, \quad \alpha_1^t + \alpha_2^t + \alpha_3^t - \pi = 0;$$

- Planarity:

$$\forall v \in V_{int}, \quad \sum_{(t,k) \in v^*} \alpha_k^t - 2\pi = 0$$

- Reconstruction

$$\forall v \in V_{int}, \quad \prod_{(t,k) \in v^*} \sin \alpha_{k \oplus 1}^t - \prod_{(t,k) \in v^*} \sin \alpha_{k \ominus 1}^t = 0$$

- Positivity

$$\alpha_j^t > 0$$

- Distortion:

$$\sum_{t \in T, j=1 \dots 3} w_j^t (\alpha_j^t - \beta_j^t)^2, w_j^t = 1/\beta_j^{t^2}$$

Angle to UV Conversion

- Use computed angles as input to LSCM (it is a reproducing method..)

Examples

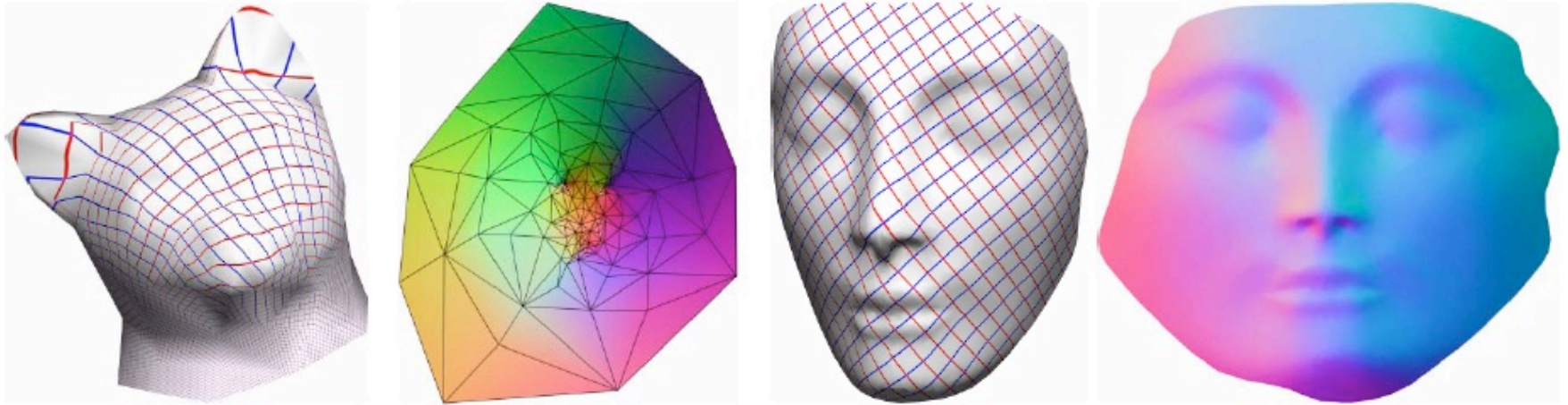

Parameterization with LSCM [Lévy et al. 2002].

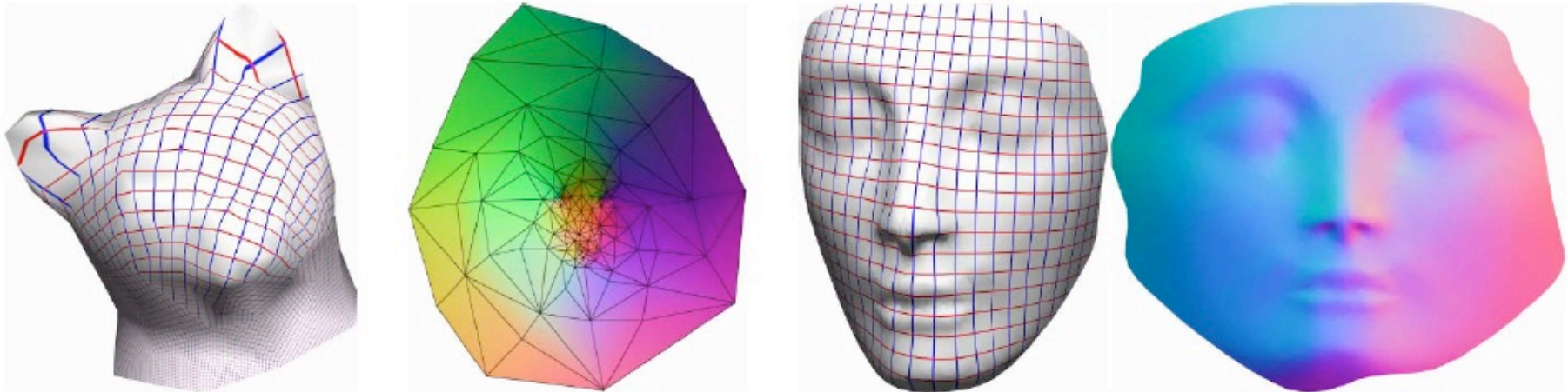

Parameterization with ABF++ [Sheffer et al. 2005].

Examples

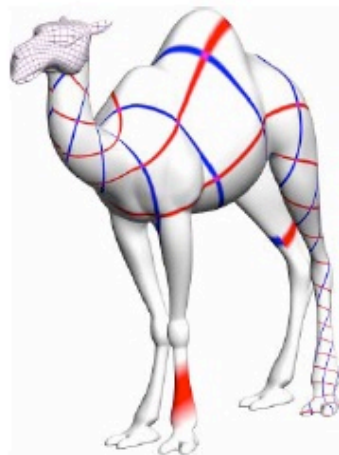
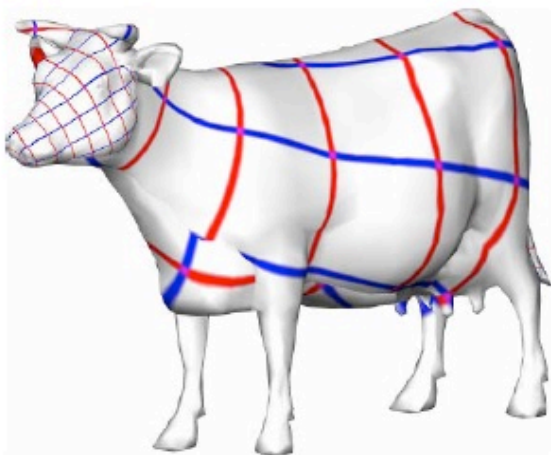

Parameterization with LSCM [Lévy et al. 2002].

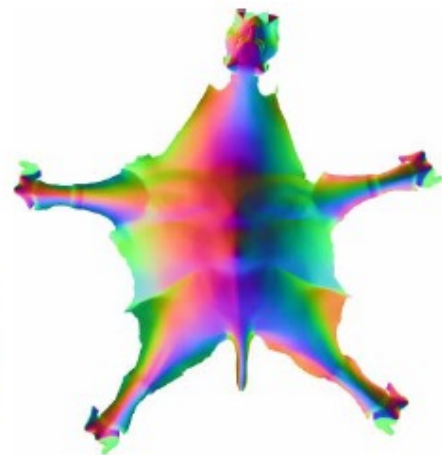
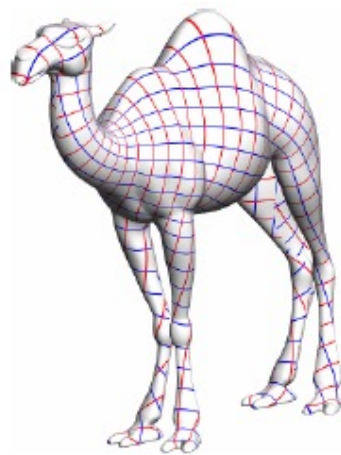
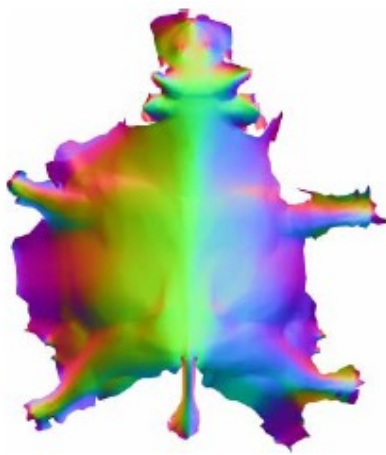
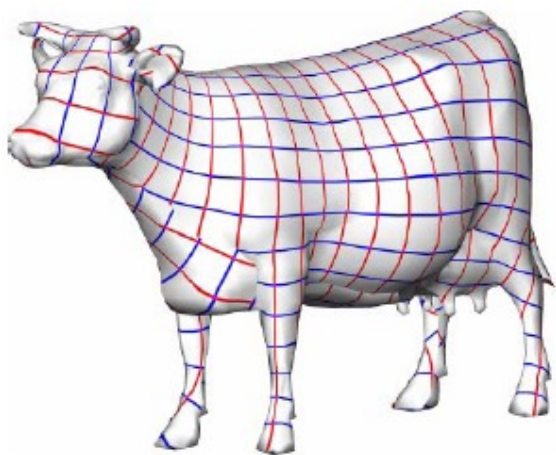

Parameterization with ABF++ [Sheffer et al. 2005].

Cone Singularities [Kharevych:06]

- What separates boundary from interior in angle space?
- Answer: Sum of angles at vertex
- Formulation specific

– ABF/ABF++

- Planarity & Reconstruction

$$\forall v \in V_{int}, \quad \sum_{(t,k) \in v^*} \alpha_k^t - 2\pi = 0$$

- But... reconstruction can be enforced on boundaries

$$\forall v \in V_{int}, \quad \prod_{(t,k) \in v^*} \sin \alpha_{k \oplus 1}^t - \prod_{(t,k) \in v^*} \sin \alpha_{k \ominus 1}^t = 0$$

Cone Singularities

- Idea: Reduce boundary to small set of vertices
- Implementation:
 - Enforce “interior” constraints at all other vertices
- To unfold choose any sequence of edges connecting “boundary” vertices

Circle Patterns + Cone Singularities

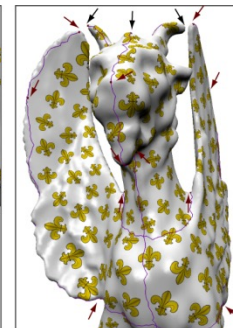
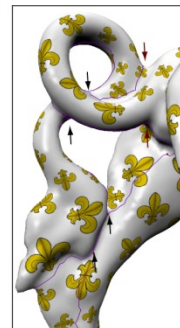
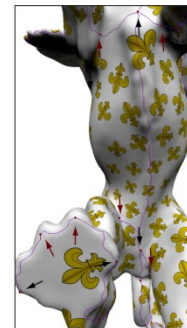
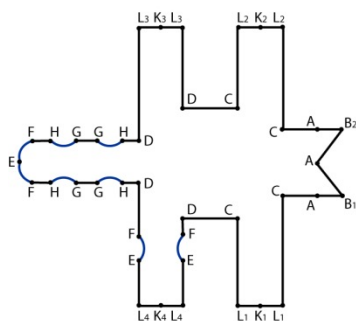
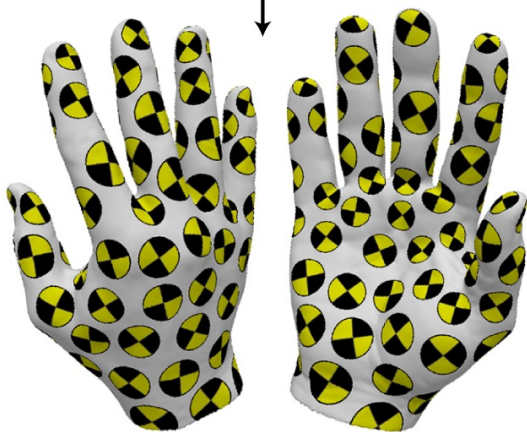
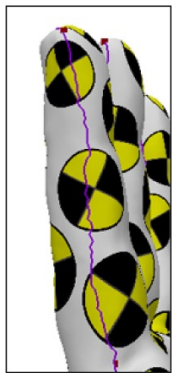
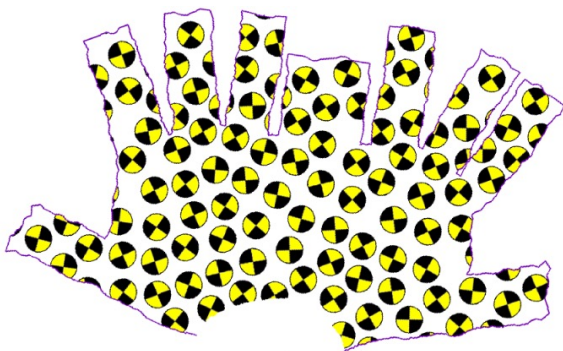
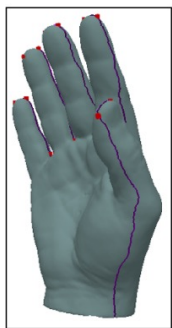

ABF + Cone Singularities

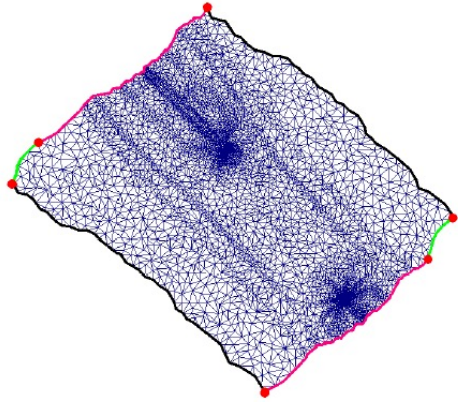
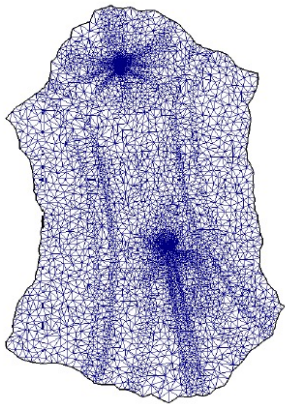
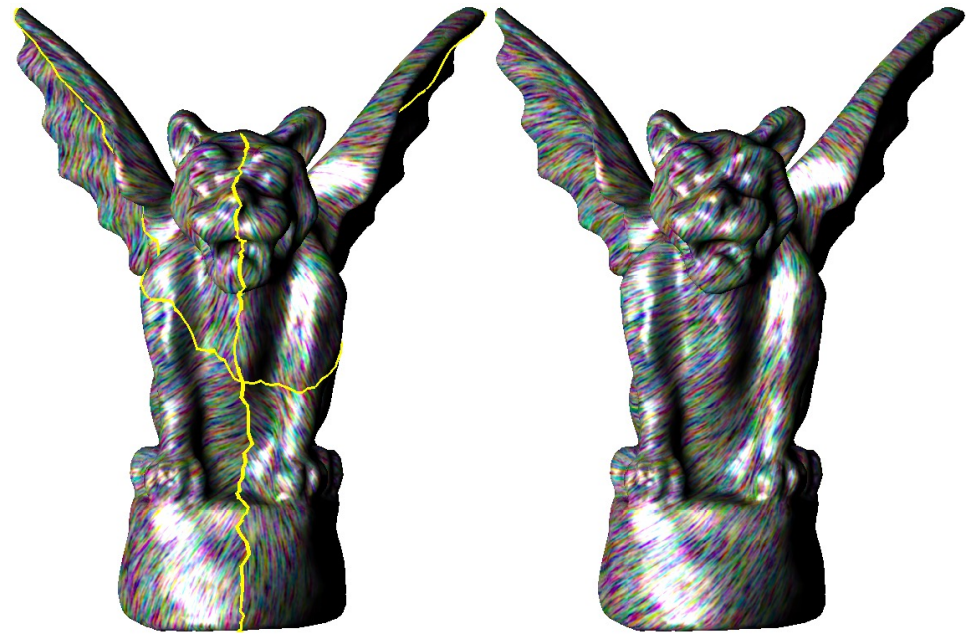
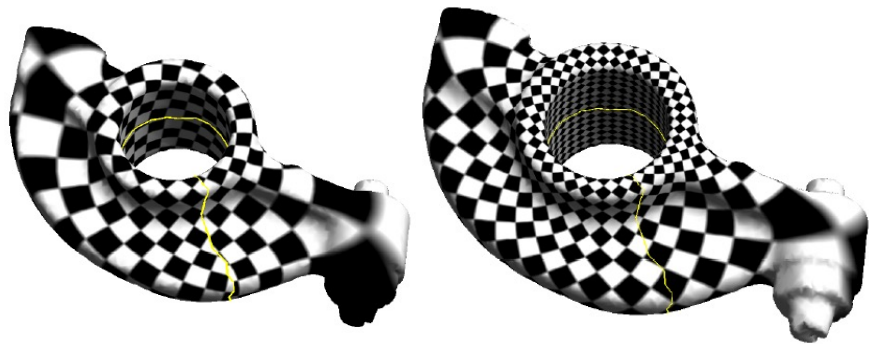

General Framework

- Choose an energy

Name	$\mathcal{D}(\mathbf{J})$	$\mathcal{D}(\sigma)$
Symmetric Dirichlet	$\ \mathbf{J}\ _F^2 + \ \mathbf{J}^{-1}\ _F^2$	$\sum_{i=1}^n (\sigma_i^2 + \sigma_i^{-2})$
Exponential Symmetric Dirichlet	$\exp(s(\ \mathbf{J}\ _F^2 + \ \mathbf{J}^{-1}\ _F^2))$	$\exp(s \sum_{i=1}^n (\sigma_i^2 + \sigma_i^{-2}))$
Hencky strain	$\ \log \mathbf{J}^\top \mathbf{J}\ _F^2$	$\sum_{i=1}^n (\log^2 \sigma_i)$
AMIPS	$\exp(s \cdot \frac{1}{2} (\frac{\text{tr}(\mathbf{J}^\top \mathbf{J})}{\det(\mathbf{J})} + \frac{1}{2} (\det(\mathbf{J}) + \det(\mathbf{J}^{-1}))))$	$\exp(s (\frac{1}{2} (\frac{\sigma_1}{\sigma_2} + \frac{\sigma_2}{\sigma_1}) + \frac{1}{4} (\sigma_1 \sigma_2 + \frac{1}{\sigma_1 \sigma_2})))$
Conformal AMIPS 2D	$\frac{\text{tr}(\mathbf{J}^\top \mathbf{J})}{\det(\mathbf{J})}$	$\frac{\sigma_1^2 + \sigma_2^2}{\sigma_1 \sigma_2}$
Conformal AMIPS 3D	$\frac{\text{tr}(\mathbf{J}^\top \mathbf{J})}{\det(\mathbf{J})^{\frac{2}{3}}}$	$\frac{\sigma_1^2 + \sigma_2^2 + \sigma_3^2}{(\sigma_1 \sigma_2 \sigma_3)^{\frac{2}{3}}}$

Recall:

Gradient of a Hat Function

$$\|\nabla f\| = \frac{1}{l_3 \sin \theta_3} = \frac{1}{h}$$

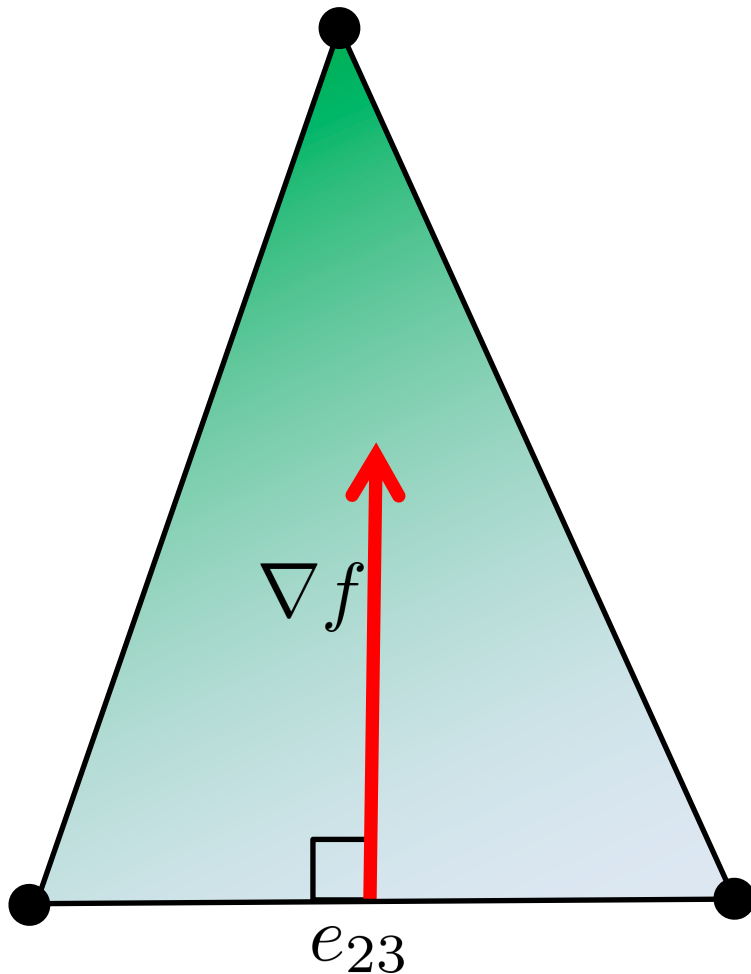

$$\nabla f = \frac{e_{23}^\perp}{2A}$$

Length of e_{23} cancels
"base" in A

Parameterization Jacobian

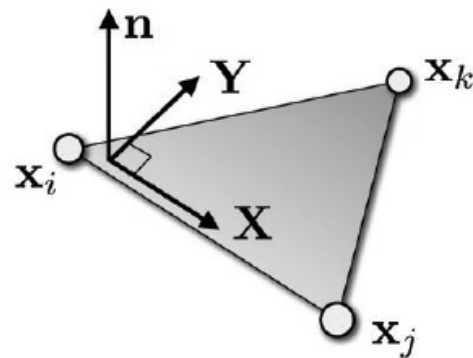

$$\mathbf{X} = \frac{\mathbf{x}_j - \mathbf{x}_i}{\|\mathbf{x}_j - \mathbf{x}_i\|}$$

$$\mathbf{n} = \frac{\mathbf{X} \times (\mathbf{x}_k - \mathbf{x}_i)}{\|\mathbf{X} \times (\mathbf{x}_k - \mathbf{x}_i)\|}$$

$$\mathbf{Y} = \mathbf{n} \times \mathbf{X}$$

Figure 5.9. Local X, Y basis in a triangle.

$$\nabla u = \begin{bmatrix} \partial u / \partial X \\ \partial u / \partial Y \end{bmatrix} = \underbrace{\frac{1}{2 A_T} \begin{bmatrix} Y_j - Y_k & Y_k - Y_i & Y_i - Y_j \\ X_k - X_j & X_i - X_k & X_j - X_i \end{bmatrix}}_{= \mathbf{M}_T} \begin{pmatrix} u_i \\ u_j \\ u_k \end{pmatrix}$$

Parameterization Jacobian

$$\nabla u = \begin{bmatrix} \partial u / \partial X \\ \partial u / \partial Y \end{bmatrix} = \frac{1}{2 A_T} \underbrace{\begin{bmatrix} Y_j - Y_k & Y_k - Y_i & Y_i - Y_j \\ X_k - X_j & X_i - X_k & X_j - X_i \end{bmatrix}}_{= \mathbf{M}_T} \begin{pmatrix} u_i \\ u_j \\ u_k \end{pmatrix}$$

$$\mathbf{J}_T = \begin{bmatrix} \partial u / \partial X & \partial v / \partial X \\ \partial u / \partial Y & \partial v / \partial Y \end{bmatrix}$$

Conformal Energies

- **Conformal** energy

$$E_C = (\sigma_1 - \sigma_2)^2 / 2$$

[Pinkall & Polthier 1993]

[Lévy et al. 2002]

[Desbrun et al. 2002]

- **MIPS** energy

$$E_M = \kappa_F(J_f) = \|J_f\|_F \|J_f^{-1}\|_F = \frac{\sigma_1}{\sigma_2} + \frac{\sigma_2}{\sigma_1}$$

[Hormann & Greiner 2000]

- **Riemann theorem:** any C^1 continuous surface in \mathbb{R}^3 can be mapped conformally to fixed domain in \mathbb{R}^2
 - Nearly true for meshes

Detailed Example

Given a triangle T with 2D texture coordinates p_1, p_2, p_3 , $p_i = (s_i, t_i)$, and corresponding 3D coordinates q_1, q_2, q_3 , the unique affine mapping $S(p) = S(s, t) = q$ is

$$S(p) = (\langle p, p_2, p_3 \rangle q_1 + \langle p, p_3, p_1 \rangle q_2 + \langle p, p_1, p_2 \rangle q_3) / \langle p_1, p_2, p_3 \rangle$$

$$S_s = \partial S / \partial s = (q_1(t_2 - t_3) + q_2(t_3 - t_1) + q_3(t_1 - t_2)) / (2A)$$

$$S_t = \partial S / \partial t = (q_1(s_3 - s_2) + q_2(s_1 - s_3) + q_3(s_2 - s_1)) / (2A)$$

$$A = \langle p_1, p_2, p_3 \rangle = ((s_2 - s_1)(t_3 - t_1) - (s_3 - s_1)(t_2 - t_1)) / 2$$

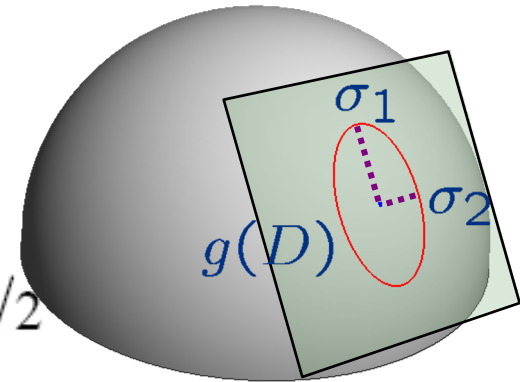

Singular values: $\sqrt{0.5((a + c) \pm \sqrt{(a - c)^2 + 4b^2})}$

$a = S_s \cdot S_s$, $b = S_s \cdot S_t$, and $c = S_t \cdot S_t$

General Framework

- Choose an energy
- Start with an initial bijective parameterization
 - E.g. Tutte

General Framework

- Choose an energy
- Start with an initial bijective parameterization
 - E.g. Tutte
- Use nonlinear optimization tools to minimize
 - Gradient descent
 - Quasi-Newton methods
 - ...

General Framework

- Choose an energy
- Start with an initial bijective parameterization
 - E.g. Tutte
- Use nonlinear optimization tools to minimize
 - Gradient descent
 - Quasi-Newton methods
 - ...
- How to preserve **bijectivity**?

What is gradient of E w/r to positions?

What is gradient of E w/r to positions?

A vector field!

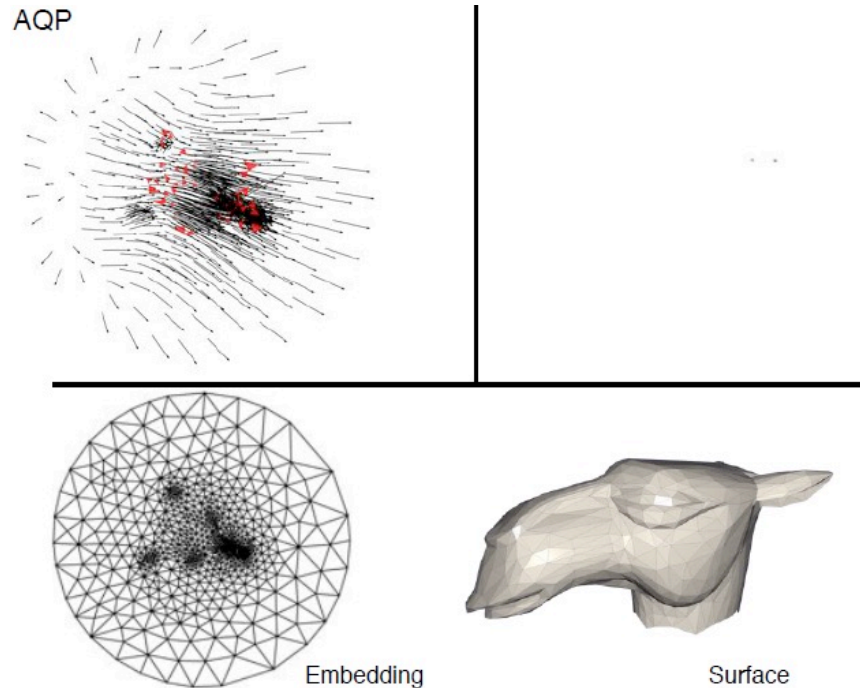

Scaling vector field

- Find a scale parameter, s.t. nothing flips if we add the vector field
- Limit line search step to this value

Bijjective Parameterization with Free Boundaries

Jason Smith*
Texas A&M University

Scott Schaefer†
Texas A&M University

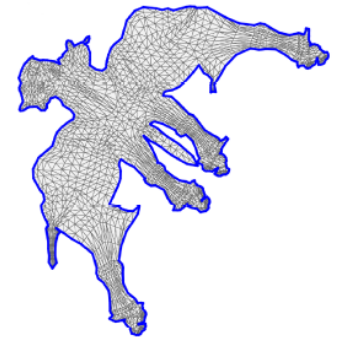
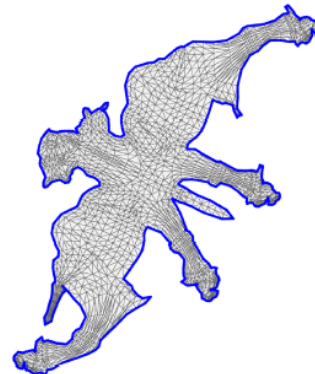
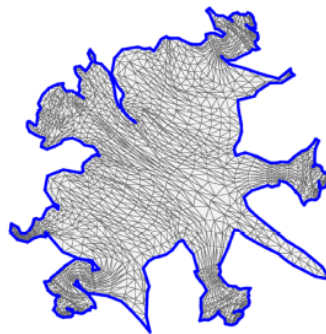
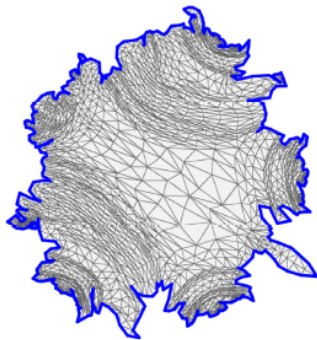
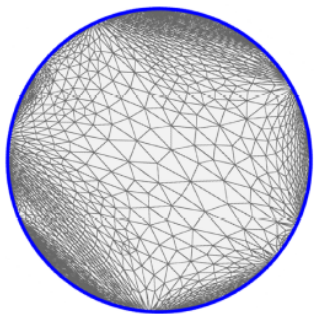

Issues

- Only local injectivity

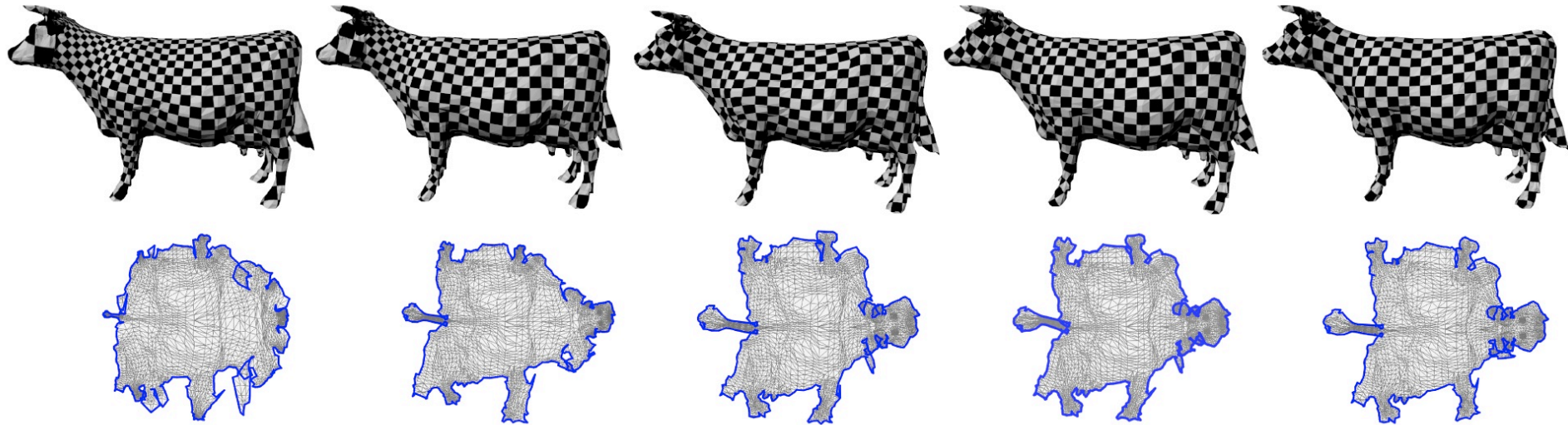

Issues

- Only local injectivity
- Sometimes the step size is too small
 - One almost inverted triangle is enough

