

Challenges in Stochastic Modeling of Service Systems: Illustrations with Call Centers

Pierre L'Ecuyer

Université de Montréal, Canada

and

Inria–Rennes, France

Thanks to Wyeon Chan, Rouba Ibrahim, Boris Oreshkin, Nazim Régnard,
Laure Leblanc, Delphine Réau

Rotman School of Management, Toronto, November 2014

Simulation Challenges

Want to simulate large complex systems to study their behavior and improve decision making.

Examples: Climate change and environment



Need **three-dimensional dynamic models** for concentrations of greenhouse gases CO_2 , CH_4 , N_2O , freons, etc., aerosols, water vapor, air temperature, water temperature, water currents, surface ice and snow, clouds, etc.

Stochastic aspects.

Simulating a whole human body, or one of its parts.

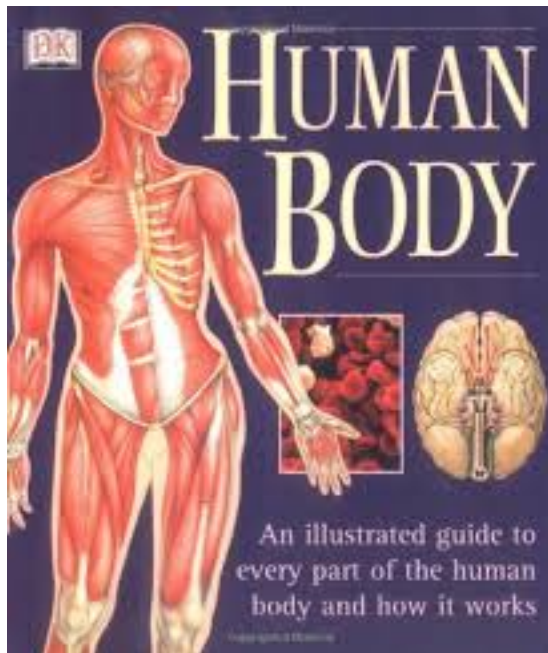

Spread of infectious diseases, mutations, resistance.

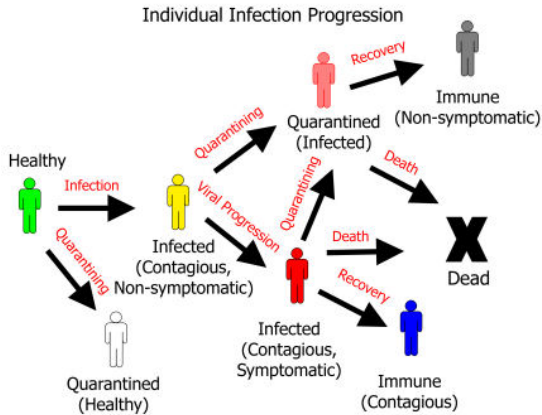

E.g., virus and bacteria in large populations of humans, animals, and plants. Resistance to antibiotics. Etc.

Social networks, crowd behavior, evacuations, ...

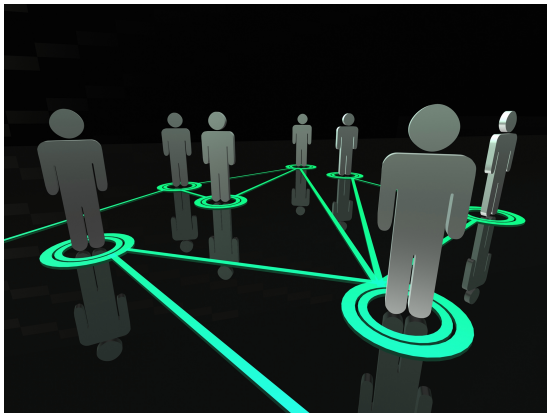

Fertile ground for agent-based modeling.

Behaviors are stochastic and not independent, not easy to model.

Communication networks (various devices, stochastic demand)

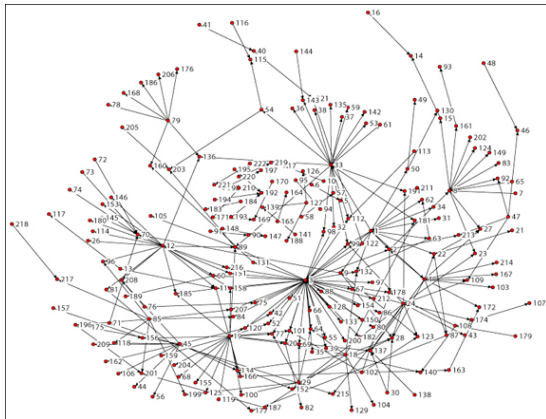

Modeling (or even forecasting) the stochastic demand is difficult.
Lots of dependence.

Transportation networks, logistic and distribution systems.



Similar problems. Uncertain demands and travel times.

Stochastic models in finance and economics. Risk analysis.



Much uncertainty here. Most models are SDEs based on historical data. How to better exploit external knowledge? Dependence between asset prices in a portfolio (beyond correlations) has a large impact on risk.

Health-care (clinics, hospitals, ambulances, patient evolution)

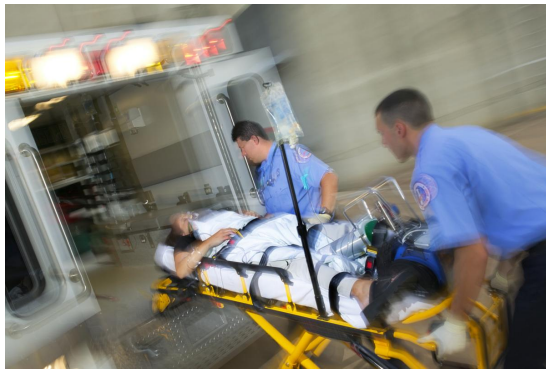

Stochastic demand, the evolution of each patient involves uncertainty, etc.

Telephone call centers (or contact centers)



Include sales by telephone, customer service, billing/recovery, public services, 911, taxis, pizza order, etc. Employ around 3% of workforce in North America. More than agriculture!

Simulation Challenges

Want to simulate large complex systems to study their behavior and improve decision making.

- ▶ Speed of execution of large simulations.
- ▶ Interoperability, interaction between models, reuse, standards, etc.
- ▶ Modeling methodology and tools for large and complex systems.
Agent-based modeling. Modeling human behavior.

Simulation Challenges

Want to simulate large complex systems to study their behavior and improve decision making.

- ▶ Simulation-based **optimization** and control.
- ▶ Speed of execution of large simulations.
- ▶ Interoperability, interaction between models, reuse, standards, etc.
- ▶ Modeling methodology and tools for large and complex systems.
Agent-based modeling. Modeling human behavior.

Simulation Challenges

Want to simulate large complex systems to study their behavior and improve decision making.

- ▶ Trustable (valid) **stochastic modeling** of complex systems.
Taking account of various type of external information.
- ▶ Simulation-based **optimization** and control.
- ▶ Speed of execution of large simulations.
- ▶ Interoperability, interaction between models, reuse, standards, etc.
- ▶ Modeling methodology and tools for large and complex systems.
Agent-based modeling. Modeling human behavior.

Big Data

Sometimes **huge amounts of data** available to build stochastic models. How can we exploit this huge mass of data to build credible models?

How to effectively **update the models** in real time as new data comes in?

Strong links with data mining, machine learning, Bayesian statistics.

Generally much more complicated than selecting univariate distributions and estimating their parameters. Model inputs are often multivariate distributions and stochastic processes, with hard-to-model (but important) **dependence** between them, and parameters that are themselves **stochastic**.

Illustrative Example: A Multiskill Call Center

Different **call types**. Depends on required skill, language, importance, etc.
Agent types (groups). Each has a set of **skills** to handle certain call types.
 Service time distribution may depend on pair $\langle \text{call type, agent group} \rangle$.

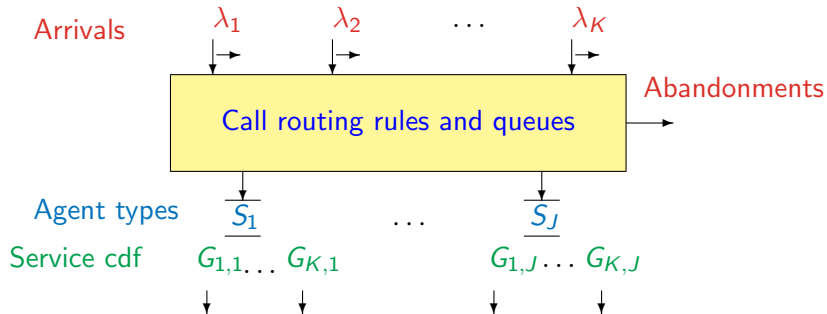

Baby Example: the N Model

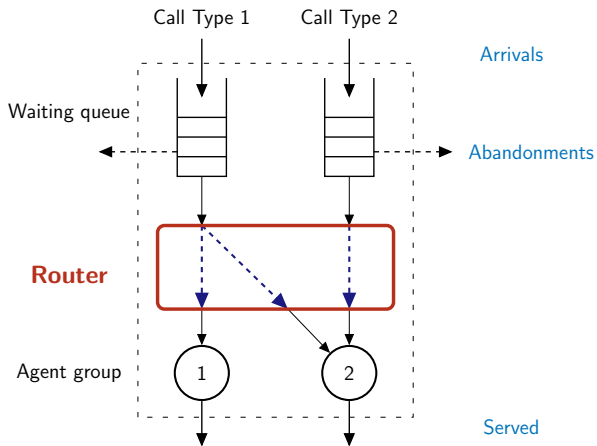

Here, group 2 can serve both call types.

In large call centers, can have over 100 call types and agent groups.

Typical call center

Arrival process is nonstationary and much more complicated than Poisson.

Service times are not exponential and not really independent.

Abandonments (balking + reneging), retrials, returns, etc.

Typical call center

Arrival process is nonstationary and much more complicated than Poisson.

Service times are not exponential and not really independent.

Abandonments (balking + reneging), retries, returns, etc.

Skill-based routing: Rules that control in real time the **call-to-agent** and **agent-to-call** assignments. Can be complex in general.

Static vs dynamic rules. (e.g., using weights).

Typical call center

Arrival process is nonstationary and much more complicated than Poisson.

Service times are not exponential and not really independent.

Abandonments (balking + reneging), retrials, returns, etc.

Skill-based routing: Rules that control in real time the **call-to-agent** and **agent-to-call** assignments. Can be complex in general.

Static vs dynamic rules. (e.g., using weights).

Agents using fewer skills tend to work faster. Also less expensive.

Compromise between single-skill agents (specialists) vs flexible multiskill agents (generalists).

Staffing/scheduling/routing optimization: **objective function** and **constraints** can account for cost of agents, service-level, expected excess waiting time, average wait, abandonment ratios, agent occupancy ratios, fairness in service levels and in agent occupancies, etc. Various constraints on work schedules.

Examples of common performance measures

Service level: $SL(\tau)$ = fraction of calls answered within **acceptable waiting time** τ . (May exclude calls that abandon before τ .)

May consider its observed value over a fixed time period (random variable), or its expectation, or the average in the long run (infinite horizon), or a tail probability $\mathbb{P}[SL(\tau) \geq \ell]$.

Examples of common performance measures

Service level: $SL(\tau)$ = fraction of calls answered within **acceptable waiting time** τ . (May exclude calls that abandon before τ .)

May consider its observed value over a fixed time period (random variable), or its expectation, or the average in the long run (infinite horizon), or a tail probability $\mathbb{P}[SL(\tau) \geq \ell]$.

Abandonment ratio: fraction of calls that abandon.

Average waiting time for each call type.

Agent occupancy: fraction of the time where each agent is busy.

Performance evaluation, single call type

Arrival rate λ , service rate μ , load λ/μ , s servers, waiting time W .

Assumes Poisson arrivals with constant rate (not realistic) + single type.

$M/M/s$ queue (Erlang-C). CTMC model.

Approx. of $\mathbb{P}[W > 0]$, $\mathbb{P}[W > \tau]$, and $\mathbb{E}[W]$.

Performance evaluation, single call type

Arrival rate λ , service rate μ , load λ/μ , s servers, waiting time W .

Assumes Poisson arrivals with constant rate (not realistic) + single type.

$M/M/s$ queue (Erlang-C). CTMC model.

Approx. of $\mathbb{P}[W > 0]$, $\mathbb{P}[W > \tau]$, and $\mathbb{E}[W]$.

Approximation under quality and efficiency driven (QED) regime:

$\lambda \rightarrow \infty$ and $s \rightarrow \infty$ with $\alpha = \mathbb{P}[W > 0] \in (0, 1)$ fixed.

Halfin and Whitt (1981).

Square root safety staffing: $s^* = \lceil \lambda/\mu + \beta \sqrt{\lambda/\mu} \rceil$.

Could make sense for some large call centers.

Performance evaluation, single call type

Arrival rate λ , service rate μ , load λ/μ , s servers, waiting time W .

Assumes Poisson arrivals with constant rate (not realistic) + single type.

$M/M/s$ queue (Erlang-C). CTMC model.

Approx. of $\mathbb{P}[W > 0]$, $\mathbb{P}[W > \tau]$, and $\mathbb{E}[W]$.

Approximation under quality and efficiency driven (QED) regime:

$\lambda \rightarrow \infty$ and $s \rightarrow \infty$ with $\alpha = \mathbb{P}[W > 0] \in (0, 1)$ fixed.

Halfin and Whitt (1981).

Square root safety staffing: $s^* = \lceil \lambda/\mu + \beta \sqrt{\lambda/\mu} \rceil$.

Could make sense for some large call centers.

$M/M/s + M$ queue (Erlang-A).

Approx. of $\gamma = \mathbb{P}[\text{abandon}]$, $\mathbb{P}[W > 0]$, and $\alpha = \mathbb{P}[W > \tau]$.

QED(τ): Fix τ , α , and $\gamma > 0$.

Modified square root rule: $s^* = \lceil (1 - \gamma)\lambda/\mu + \delta \sqrt{(1 - \gamma)\lambda/\mu} \rceil$.

Multiple call types, multiskill agents

Much more difficult.

Call routing rules become important and can be complicated.

Approximations for service levels are not very good.

Must [rely on simulation](#).

In our lab, we develop [ContactCenters](#), a Java simulation and optimization software library for contact centers. Also some tools for model estimation from data.

Data on call arrivals

Available observations (for each day): $\mathbf{X} = (X_1, \dots, X_p)$, arrival counts over (15 or 30 minutes) successive time periods.

Data on call arrivals

Available observations (for each day): $\mathbf{X} = (X_1, \dots, X_p)$, arrival counts over (15 or 30 minutes) successive time periods.

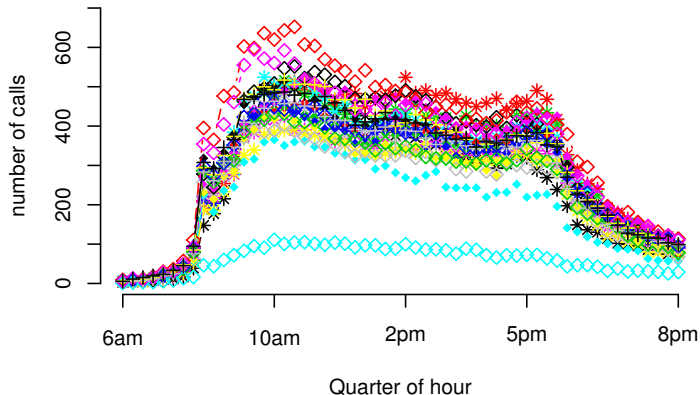

Ex.: Typical realizations of \mathbf{X} for a **Monday** (15-min periods).

Non-stationary. Strong dependence between the X_j 's.

Similar behavior in many **other settings**: customer arrivals at stores, incoming demands for a product, arrivals at hospital emergency, etc.

All days, call volumes before and after $T = 2$ p.m.

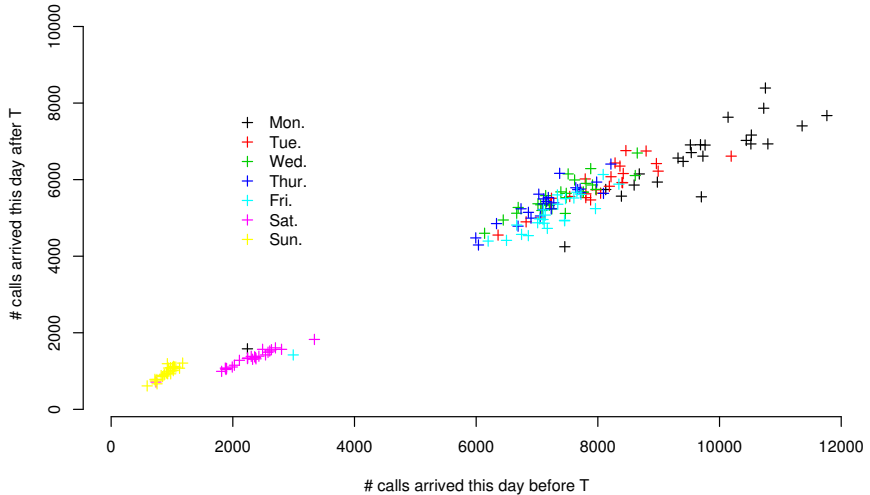

Modeling the arrivals

Stationary Poisson process as in Erlang formulas? **No.**

Modeling the arrivals

Stationary Poisson process as in Erlang formulas? **No.**

Poisson process with time-dependent arrival rate $\lambda(t)$?

Would imply that $\text{Var}[X_j] = \mathbb{E}[X_j]$. Typically **far from true.**

Modeling the arrivals

Stationary Poisson process as in Erlang formulas? **No.**

Poisson process with time-dependent arrival rate $\lambda(t)$?

Would imply that $\text{Var}[X_j] = \mathbb{E}[X_j]$. Typically **far from true.**

True **arrival rate** depends on several factors that are hard to predict. We can view it as **stochastic**, say

$$\Lambda_j = B_j \lambda_j \quad \text{and} \quad X_j \sim \text{Poisson}(\Lambda_j) \quad \text{over period } j, \text{ where}$$

$\mathbf{B} = (B_1, \dots, B_p)$ = vector of random **busyness factors** with $\mathbb{E}[B_j] = 1$,

$\boldsymbol{\lambda} = (\lambda_1, \dots, \lambda_p)$ = vector of constant **base rates** (scaling factors).

Modeling the arrivals

Stationary Poisson process as in Erlang formulas? **No.**

Poisson process with time-dependent arrival rate $\lambda(t)$?

Would imply that $\text{Var}[X_j] = \mathbb{E}[X_j]$. Typically **far from true.**

True **arrival rate** depends on several factors that are hard to predict. We can view it as **stochastic**, say

$$\Lambda_j = B_j \lambda_j \quad \text{and} \quad X_j \sim \text{Poisson}(\Lambda_j) \quad \text{over period } j, \text{ where}$$

$\mathbf{B} = (B_1, \dots, B_p)$ = vector of random **busyness factors** with $\mathbb{E}[B_j] = 1$,

$\boldsymbol{\lambda} = (\lambda_1, \dots, \lambda_p)$ = vector of constant **base rates** (scaling factors).

$$\text{Var}[X_j] = \mathbb{E}[\text{Var}[X_j|B_j]] + \text{Var}[\mathbb{E}[X_j|B_j]] = \lambda_j(1 + \lambda_j \text{Var}[B_j]).$$

Dispersion index (DI) and its standardized version (SDI):

$$\text{DI}(X_j) = \text{Var}[X_j]/\lambda_j = 1 + \lambda_j \text{Var}[B_j] \geq 1,$$

$$\text{SDI}(X_j) = (\text{DI}[X_j] - 1)/\lambda_j = \text{Var}[B_j].$$

$$\text{Corr}[X_j, X_k] = \frac{\text{Corr}[B_j, B_k]}{[(1 + 1/(\text{Var}[B_j]\lambda_j))(1 + 1/(\text{Var}[B_k]\lambda_k))]^{1/2}}.$$

We expect:

$\text{DI}(X_j) \gg 1$ and $\text{Corr}[X_j, X_k] \approx \text{Corr}[B_j, B_k]$ for “large” $\lambda_j \text{Var}[B_j]$;
i.e., large periods or high traffic.

$\text{DI}(X_j) \approx 1$ and $\text{Corr}[X_j, X_k] \approx 0$ for small $\lambda_j \text{Var}[B_j]$.

Approximately a Poisson process when $\lambda_j \text{Var}[B_j]$ is small.

Do we see this in real data?

$$\text{Corr}[X_j, X_k] = \frac{\text{Corr}[B_j, B_k]}{[\left(1 + 1/(\text{Var}[B_j]\lambda_j)\right)\left(1 + 1/(\text{Var}[B_k]\lambda_k)\right)]^{1/2}}.$$

We expect:

$\text{DI}(X_j) \gg 1$ and $\text{Corr}[X_j, X_k] \approx \text{Corr}[B_j, B_k]$ for “large” $\lambda_j \text{Var}[B_j]$;
i.e., large periods or high traffic.

$\text{DI}(X_j) \approx 1$ and $\text{Corr}[X_j, X_k] \approx 0$ for small $\lambda_j \text{Var}[B_j]$.

Approximately a Poisson process when $\lambda_j \text{Var}[B_j]$ is small.

Do we see this in real data?

In a simulation, we want to generate the B_j 's, then generate the arrivals one by one conditional on the piecewise-constant rates Λ_j .

Another approach (less convenient) is to model and directly generate the X_j 's, then randomize the arrival times.

Modeling the rates is harder because they are not observed!

Data from a public utility call center (U)

One call type, data aggregated over 40 15-minute periods per day, from 8:00 to 18:00, Monday to Friday, after removing special days.

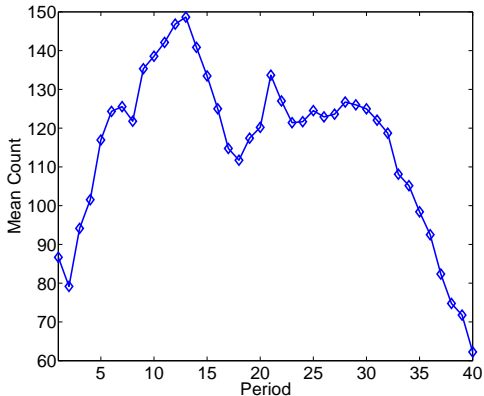

Call center U

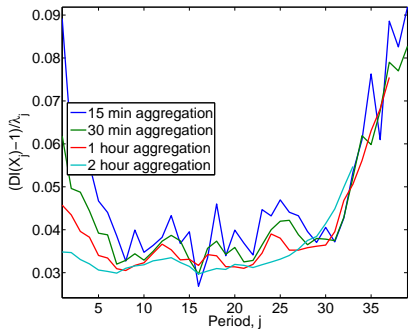
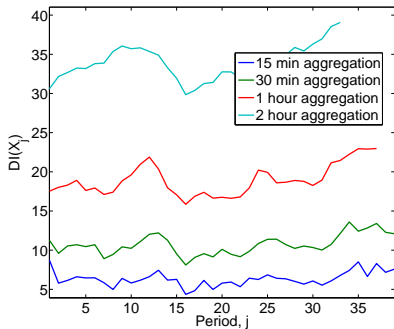

DI (left) and SDI (right) as a function of j for different period lengths.

$\text{Corr}[X_j, X_k]$ in call center U, for 30 min to 4 hour data aggregations.

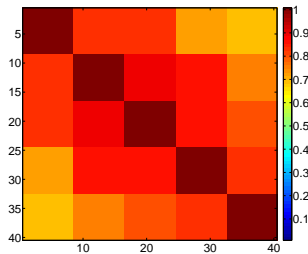
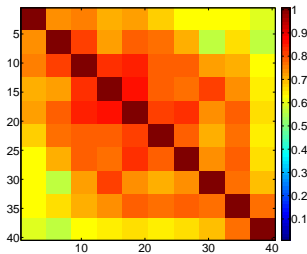
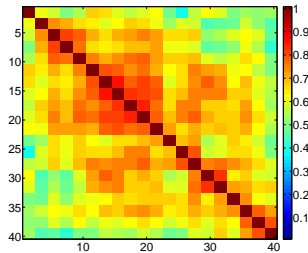
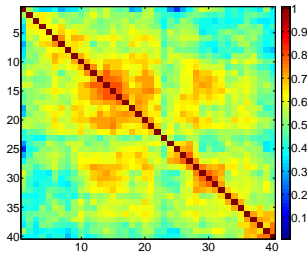

Data from an emergency call center (E)

Take **one call type**, Monday to Thursday (similar days), after removing special days (holidays, etc.). Other days have different arrival patterns. Day starts at 5 a.m. and is divided into **48 periods** of 30 minutes. Mean counts per period, $\approx \lambda_j$:

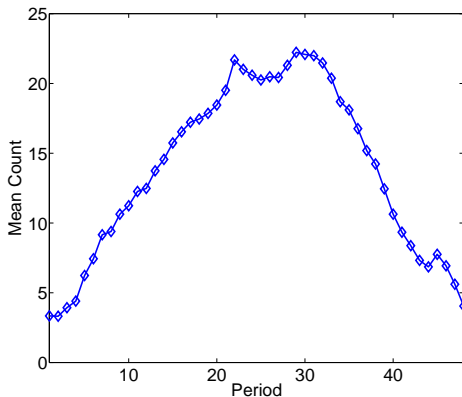

Emergency call center

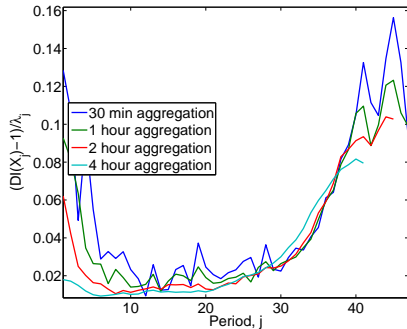
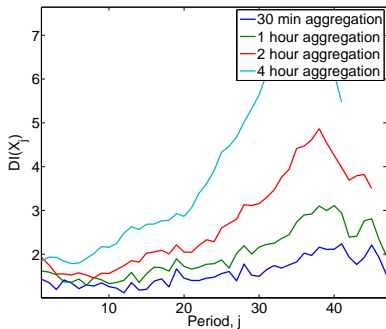

DI (left) and SDI (right) as a function of j for different period lengths.

$\text{Corr}[X_j, X_k]$ in call center E, for 30 min to 4 hour data aggregations.

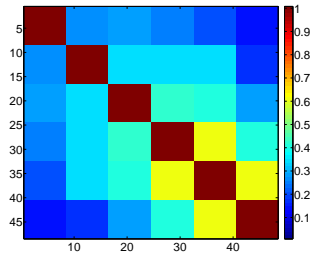
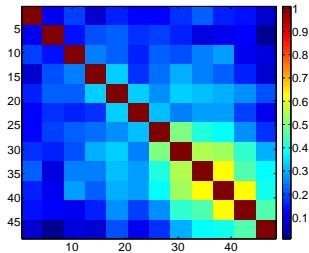
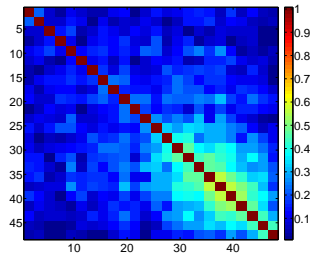
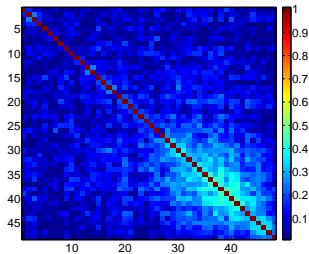

Data from a business call center (B)

One call type, Tuesday to Friday, after removing special days.

Opening hours (8:00 to 19:00) divided into 22 periods of 30 minutes.

Monday and Saturday have different patterns. Mean counts per period:

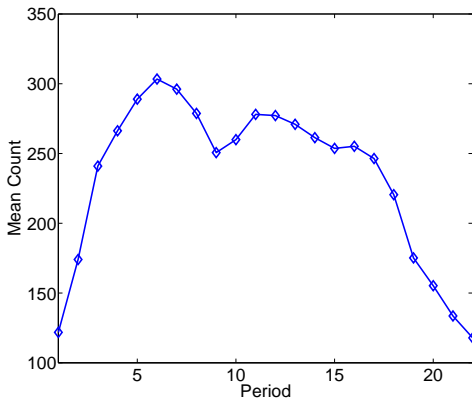

Call center B

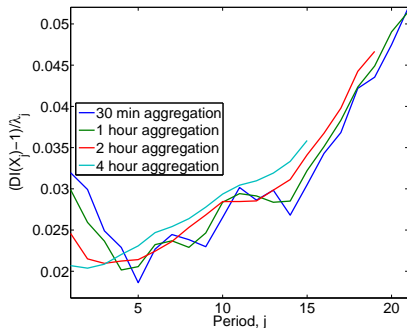
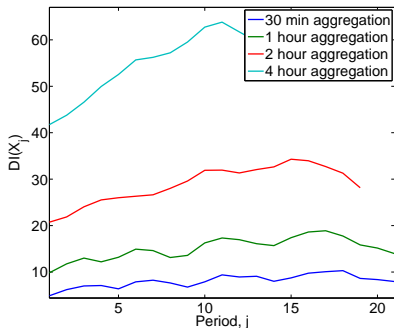

DI (left) and SDI (right) as a function of j for different period lengths. SDI is not as large as for center E, but DI is much larger.

$\text{Corr}[X_j, X_k]$ in call center B, for 30 min to 4 hour data aggregations.

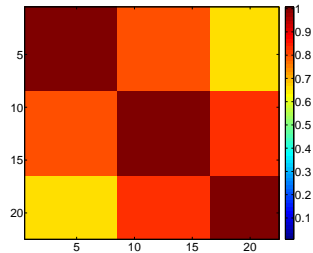
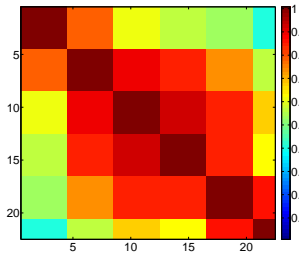
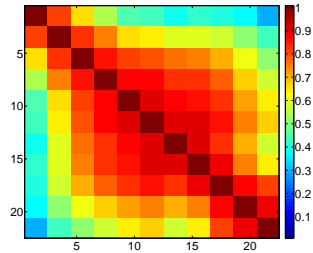
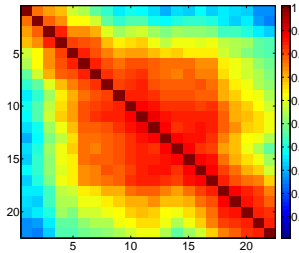

Rate models

$$\Lambda_j = B_j \lambda_j \quad \text{over period } j.$$

Poisson	$B_j = 1$ for all j .
PGsingle	$B_j = B$ for all j , where $B \sim \text{Gamma}(\alpha, \alpha)$.
PGindep	B_j 's are independent , $B_j \sim \text{Gamma}(\alpha_j, \alpha_j)$.
PG2	$B_j = \tilde{B}_j B$, combines common B and independent \tilde{B}_j 's.
PG2pow	$B_j = \tilde{B}_j B^{p_j} / \mathbb{E}[B^{p_j}]$.
PGnorta	\mathbf{B} has gamma marginals B_j and dependence specified by a normal copula (we fit all Spearman correlations). $B_j = G_j^{-1}(\Phi(Z_j))$ where $\mathbf{Z} = (Z_1, \dots, Z_p) \sim N(0, \mathbf{R})$.
PGnortaAR1	Normal copula with $\text{Corr}[Z_j, Z_k] = \rho^{ j-k }$.
PGnortaARM	Normal copula with $\text{Corr}[Z_j, Z_k] = a\rho^{ j-k } + c$.

Difficulty: We want to model the B_j 's, but they are not observed, only the X_j 's are observed. This makes **parameter estimation** by maximum likelihood (ML) much more challenging, because we have no closed form expression for the likelihood.

Moment matching is often possible, but much less robust and reliable. We use Monte Carlo-based methods for ML estimation.

Example: Likelihood Function for PG2 Model

$\tilde{B}_{i,j}$ = busyness factor for day i , period j .

\bar{B}_i = busyness factor for day i .

$$\begin{aligned}
 p(\mathbb{X}|\mathbb{B}, \beta, \alpha, \lambda) &= \int_0^\infty \dots \int_0^\infty \prod_{i=1}^I \prod_{j=1}^P \frac{(\lambda_j \tilde{B}_{i,j} \bar{B}_i)^{X_{i,j}} e^{-\lambda_j \tilde{B}_{i,j} \bar{B}_i}}{X_{i,j}!} \frac{\alpha_j^{\alpha_j} \tilde{B}_{i,j}^{\alpha_j-1} e^{-\alpha_j \tilde{B}_{i,j}}}{\Gamma(\alpha_j)} d\tilde{B}_{i,j} \\
 &= \prod_{i=1}^I \prod_{j=1}^P \int_0^\infty \frac{(\lambda_j \tilde{B}_{i,j} \bar{B}_i)^{X_{i,j}} e^{-\lambda_j \tilde{B}_{i,j} \bar{B}_i}}{X_{i,j}!} \frac{\alpha_j^{\alpha_j} \tilde{B}_{i,j}^{\alpha_j-1} e^{-\alpha_j \tilde{B}_{i,j}}}{\Gamma(\alpha_j)} d\tilde{B}_{i,j} \\
 &= \left[\prod_{j=1}^P \frac{\alpha_j^{I\alpha_j}}{\Gamma(\alpha_j)^I} \right] \prod_{i=1}^I \prod_{j=1}^P \frac{\Gamma(\alpha_j + X_{i,j})}{X_{i,j}!} \frac{(\bar{B}_i \lambda_j)^{X_{i,j}}}{(\alpha_j + \bar{B}_i \lambda_j)^{X_{i,j} + \alpha_j}} \\
 p(\mathbb{X}|\beta, \alpha, \lambda) &= \left[\prod_{j=1}^P \frac{\alpha_j^{I\alpha_j}}{\Gamma(\alpha_j)^I} \right] \left[\prod_{i=1}^I \prod_{j=1}^P \frac{\Gamma(\alpha_j + X_{i,j})}{X_{i,j}!} \right] \\
 &\quad \cdot \prod_{i=1}^I \int_0^\infty \left[\prod_{j=1}^P \frac{(\bar{B}_i \lambda_j)^{X_{i,j}}}{(\alpha_j + \bar{B}_i \lambda_j)^{X_{i,j} + \alpha_j}} \right] \frac{\beta^\beta \bar{B}_i^{\beta-1} e^{-\bar{B}_i \beta}}{\Gamma(\beta)} d\bar{B}_i.
 \end{aligned}$$

Want to maximize this. No closed form expression for the last integral.

How the models match the DI for Center U

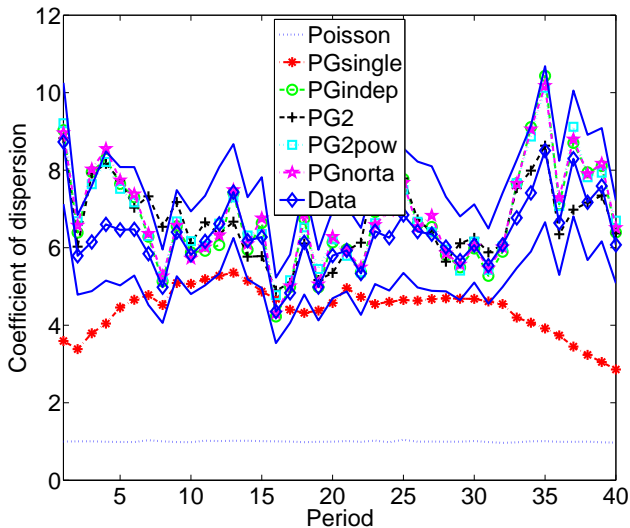

Comparison of the DI for the models and data.

How the models match the correlations for Center U

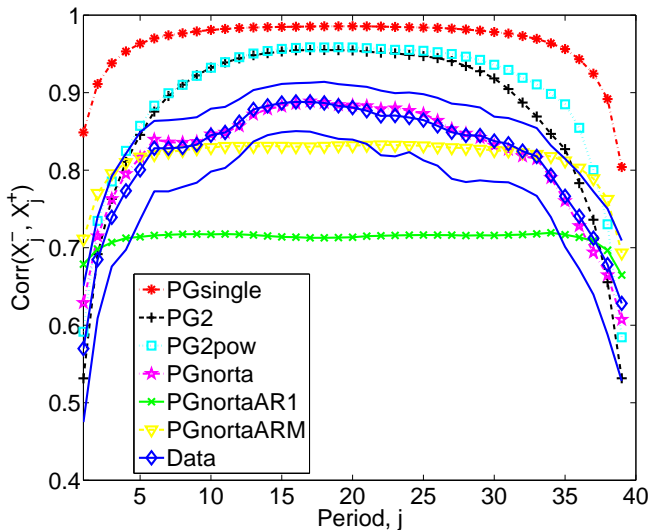

Comparison of sample correlation between past and future demand.

How the distribution predicted by the model fits the data out-of-sample

For each observation i (one day), estimate the model without that day, then for each period j (or block of successive periods) compute interval $[L_{i,j}, U_{i,j}]$ such that $\mathbb{P}[X_{i,j} \in [L_{i,j}, U_{i,j}]] \approx p$ (desired coverage) according to model, then compute the proportion of days where $X_{i,j} \in [L_{i,j}, U_{i,j}]$ and compare with p via sum of squares.

RMS Deviation of out-of-sample coverage probability, for call center U.

	75% target cover					90% target cover				
	1/4 h	1/2 h	1 h	2 h	4 h	1/4 h	1/2 h	1 h	2 h	4 h
Poisson	38.9	47.1	53.9	59.6	64.6	39.2	50.9	59.7	67.5	74.4
PGsingle	8.6	8.0	6.9	4.0	1.7	7.3	7.0	5.4	3.1	1.4
PGindep	4.5	10.5	24.6	36.5	46.3	1.8	8.4	22.3	37.8	51.2
PG2	4.4	3.4	3.8	3.3	2.2	2.0	3.0	3.5	2.5	1.7
PG2pow	4.0	2.3	2.4	2.7	2.0	1.5	1.7	1.6	1.1	1.1
PGnorta	4.4	4.1	3.9	3.4	2.7	1.8	2.2	2.4	2.3	2.4
PGnortaARM	4.4	4.0	4.2	4.0	3.2	1.8	2.3	2.5	2.7	2.2

How the models match the DI, for Center E

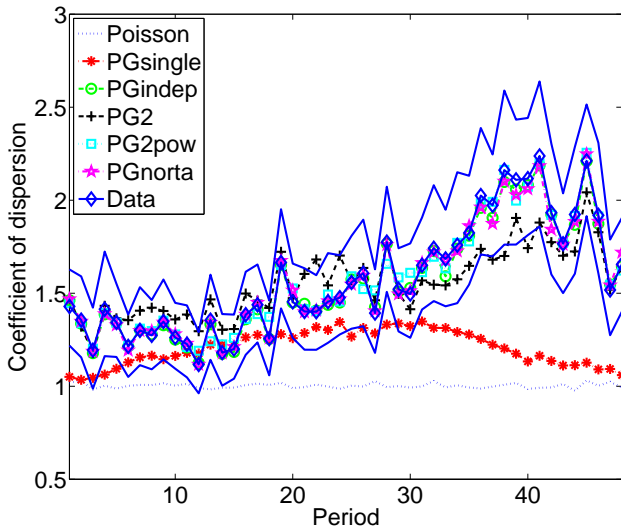

The DI for the models and data.

How the models match the correlations, for Center E

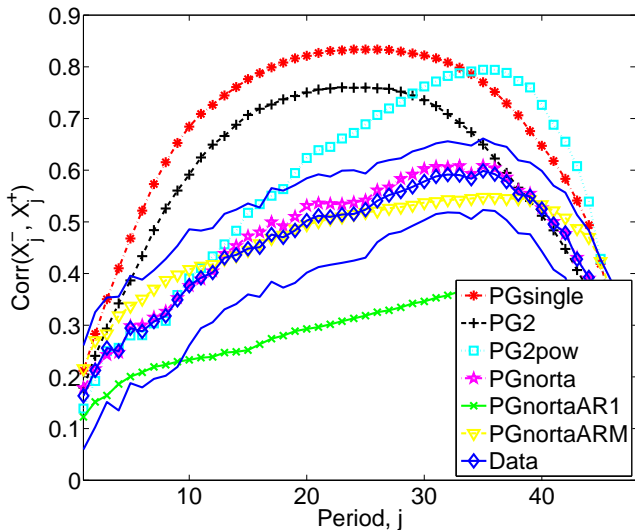

Sample correlation between past and future demand.

RMS Deviation of out-of-sample coverage probability, for call center E:

	75% target cover					90% target cover				
	0.5 h	1 h	2 h	4 h	8 h	0.5 h	1 h	2 h	4 h	8 h
Poisson	10.7	16.6	23.5	31.3	37.5	8.5	13.8	21.0	30.1	38.7
PGsingle	7.2	10.0	12.5	13.5	12.0	5.3	7.8	10.1	11.4	9.0
PGindep	1.3	5.3	12.7	21.4	29.9	0.8	4.1	10.2	18.7	29.1
PG2	2.1	4.9	8.7	11.4	11.6	1.6	3.8	6.8	9.4	8.8
PG2pow	1.5	2.9	4.4	5.1	5.0	1.0	2.0	3.1	3.4	3.0
PGnorta	1.3	1.7	1.7	1.7	1.3	0.8	1.1	1.2	1.3	0.8
PGnortaARM	1.3	2.4	3.4	4.3	4.5	0.9	1.5	2.2	2.7	2.8

How the models match the DI for Center B

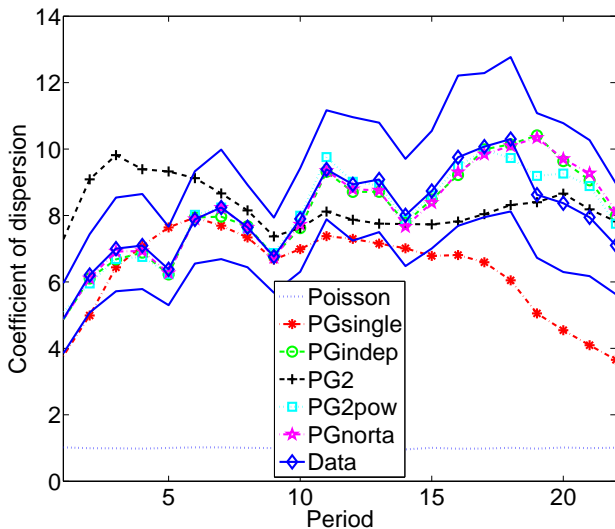

The DI for the models and data.

How the models match the correlations for Center B

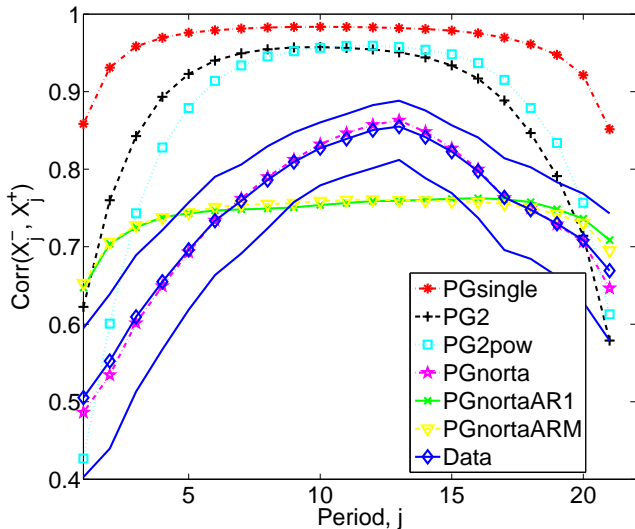

Sample correlation between past and future demand.

RMS Deviation of out-of-sample coverage probability, for call center B.

	75% target cover					90% target cover				
	0.5 h	1 h	2 h	4 h	8 h	0.5 h	1 h	2 h	4 h	8 h
Poisson	43.1	50.9	57.5	61.9	66.7	44.7	55.8	64.4	71.3	77.7
PGsingle	7.6	7.1	6.1	4.0	2.3	5.8	6.1	5.4	4.0	3.4
PGindep	3.1	13.2	27.3	39.3	48.7	2.0	12.1	26.4	41.2	51.9
PG2	4.8	4.1	5.1	4.3	2.6	3.0	2.9	3.3	2.9	2.3
PG2pow	2.5	3.3	4.1	2.0	0.8	1.7	3.3	3.7	2.8	2.7
PGnorta	3.2	3.0	2.7	1.2	1.3	2.0	2.4	2.2	1.7	2.0
PGnortaARM	3.2	3.1	2.8	1.9	0.5	2.0	2.4	2.3	2.2	2.8

Impact of choice of arrival model

Take call center U on a week day. Single call type.

Lognormal **service times** with mean 206.4 and variance 23 667 (seconds).

Abandonment at rate $1/2443$ per second.

Staffing in each period: (16, 24, 31, 36, 43, 48, 51, 52, 56, 60, 62, 65, 67, 67, 66, 65, 62, 61, 60, 61, 64, 64, 63, 63, 64, 64, 64, 64, 65, 65, 64, 64, 62, 60, 58, 56, 53, 49, 48, 44).

Performance measures:

average waiting time (**AWT**);

service level (**SL**) with threshold $\tau = 120$ seconds.

We simulated 10,000 days with each arrival model.

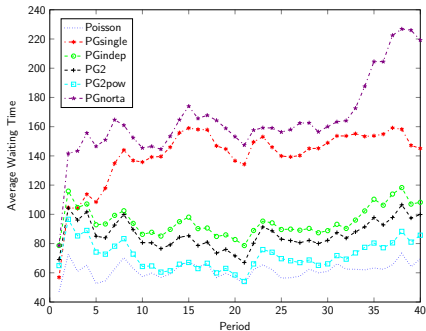
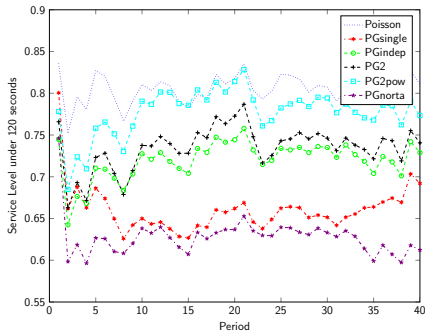

Evolution of the SL (left) and AWT in seconds (right) during the day for the Quebec utility society.

SL = proportion of calls answered within 120 seconds in the long run.

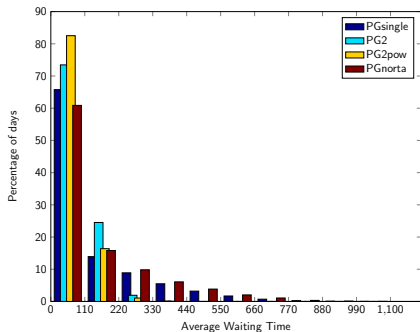
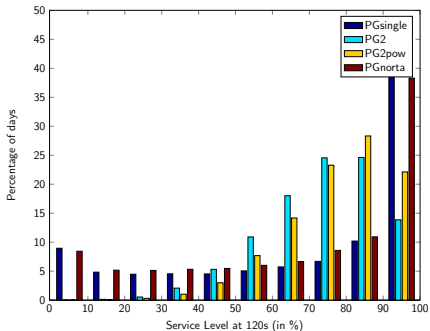

Histogram of the distribution of the daily SL (left) and daily AWT (right), with different models, for the Quebec utility society.

SL = proportion of calls answered within 120 seconds during the day.

More on arrival process modeling

Modeling the arrival rates over **successive days**.

Dependence between the days.

Seasonal effects (day of the week, period of the year).

Special days (holidays, special events, etc.).

External effects (weather, marketing campaigns, etc.).

More on arrival process modeling

Modeling the arrival rates over **successive days**.

Dependence between the days.

Seasonal effects (day of the week, period of the year).

Special days (holidays, special events, etc.).

External effects (weather, marketing campaigns, etc.).

Dependence between call types: the arrival rate should in fact be a multivariate process. Modeling via copulas.

More on arrival process modeling

Modeling the arrival rates over **successive days**.

Dependence between the days.

Seasonal effects (day of the week, period of the year).

Special days (holidays, special events, etc.).

External effects (weather, marketing campaigns, etc.).

Dependence between call types: the arrival rate should in fact be a multivariate process. Modeling via copulas.

Arrival **bursts** in emergency call center.

Modeling the service times

In call center U, the available data for service times is the number of calls of each type handled by each agent on each day, and the **average duration** of these calls. From this, we can estimate the mean and variance of a service times and match those to the mean and variance of a distribution such as lognormal or gamma.

Service times are usually **not** exponential.

Modeling the service times

In call center U, the available data for service times is the number of calls of each type handled by each agent on each day, and the **average duration** of these calls. From this, we can estimate the mean and variance of a service times and match those to the mean and variance of a distribution such as lognormal or gamma.

Service times are usually **not** exponential.

Common assumption: the distribution depends only on the call type.

But on closer examination, we find that it depends on the individual agent, on the number of call types that the agent is handling, and may change with time (learning effect, motivation and mood of agent, etc.).

This is an important fact to consider when making work schedules!

Average service time per agent for one call type, in center U (more than 1000 agents)

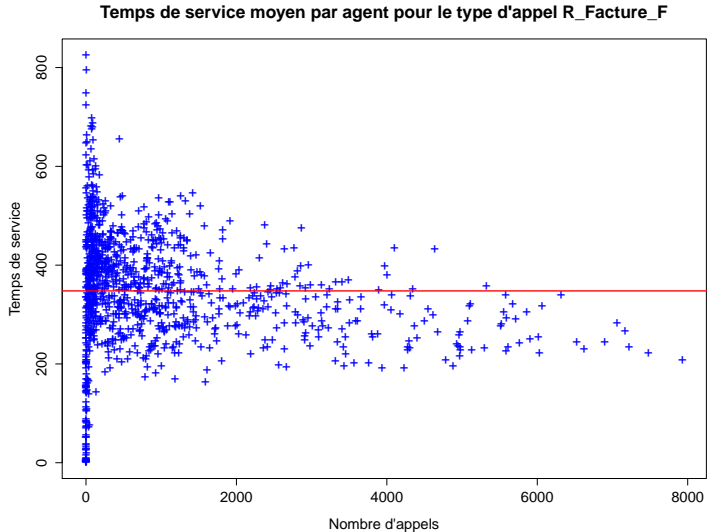

Another call type

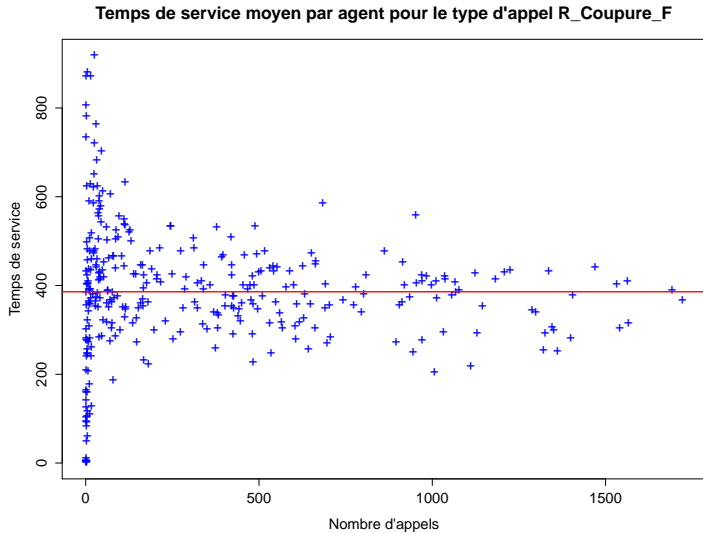

Another call type

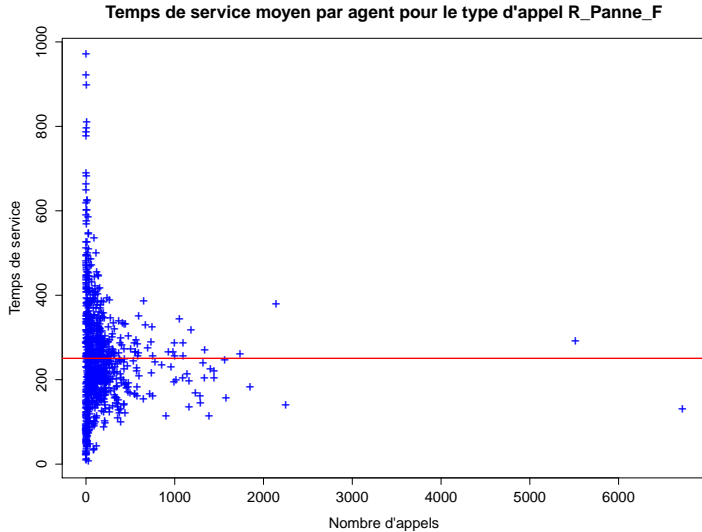

Four different agents, same call type

All have handled more than 1000 calls. Daily averages:

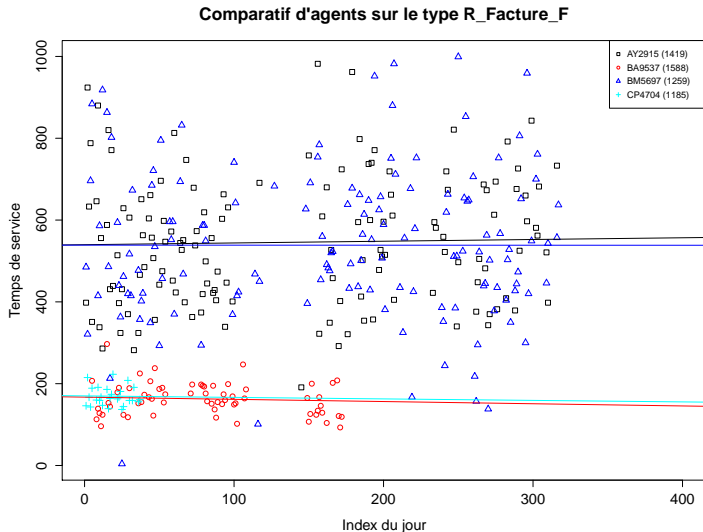

Same agent, 4 call types, weekly averages

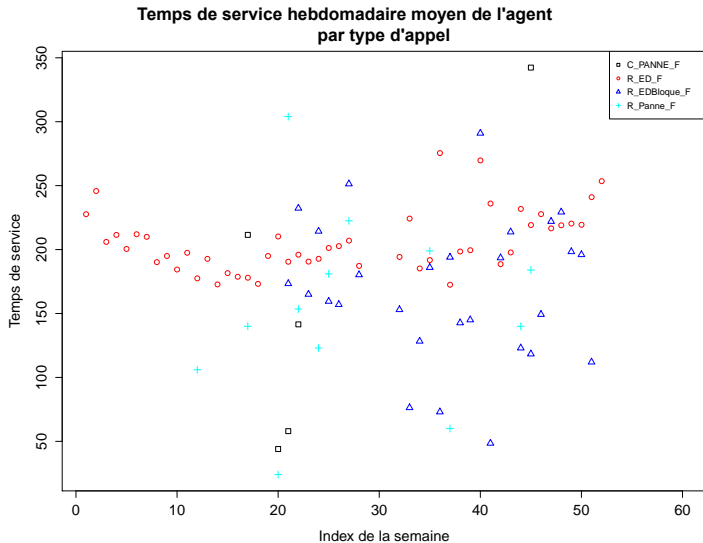

Same agent, 6 call types

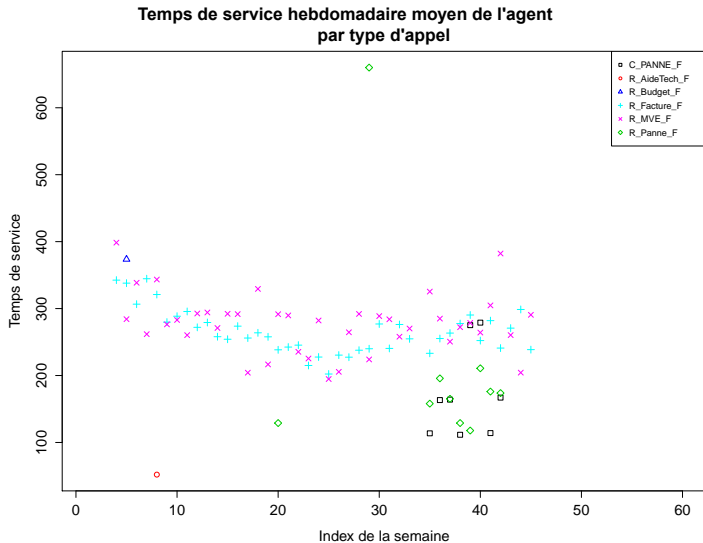

Same agent, 8 call types

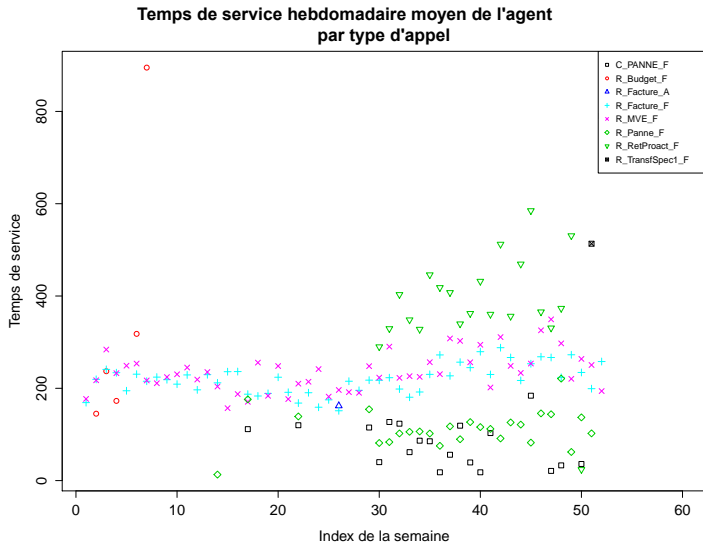

Modeling the evolution of service time averages

For given agent and call type, day i :

$$M_i = \beta_{d_i} + \alpha i + \Gamma_{w_i} + \epsilon_i,$$

where d_i = type of day i , w_i = week of day i , and Γ_i is a random effect that may follow, e.g., an AR process:

$$\Gamma_w = \rho \Gamma_{w-1} + \psi_w.$$

The ϵ_i and ψ_w are residuals (noise).

This gives better predictions than just taking the overall average for each agent.

There may also be common effects across agents.

Better: Would like to model the evolution of all distribution parameters.

Performance measures and optimization

For a given staffing and routing strategy, the SL on a given day (or given period) is a **random variable**. We may be interested in its distribution.

What if we pay a penalty iff the SL is below a given number **today**?

After solving some work-schedule optimization problem in some call center, we re-simulated with our best feasible solution for 10000 days, and computed the empirical distribution of the SL.

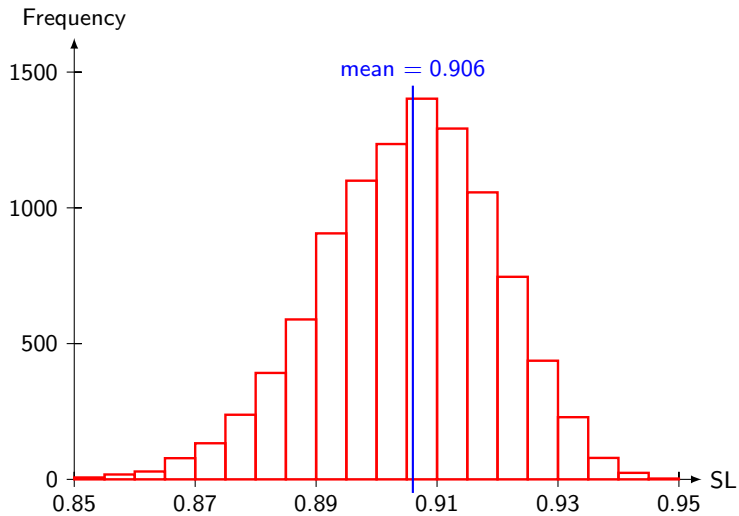

Distribution of Global SL

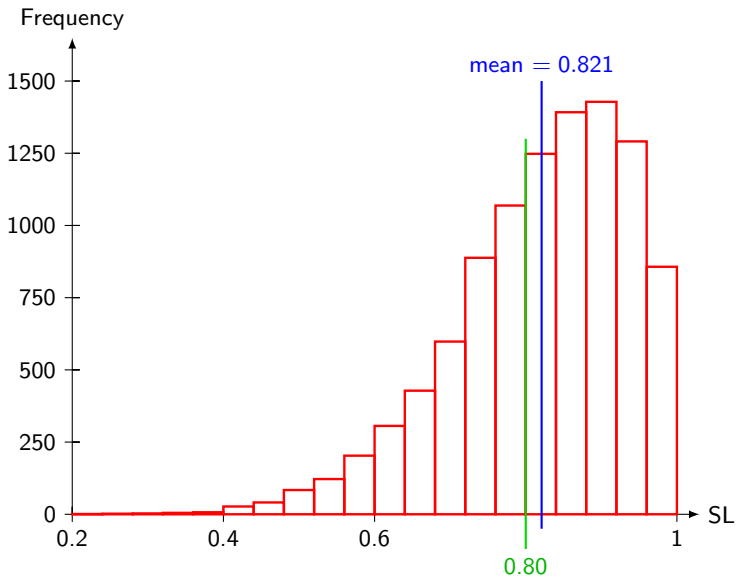

Distribution of SL Period: 7

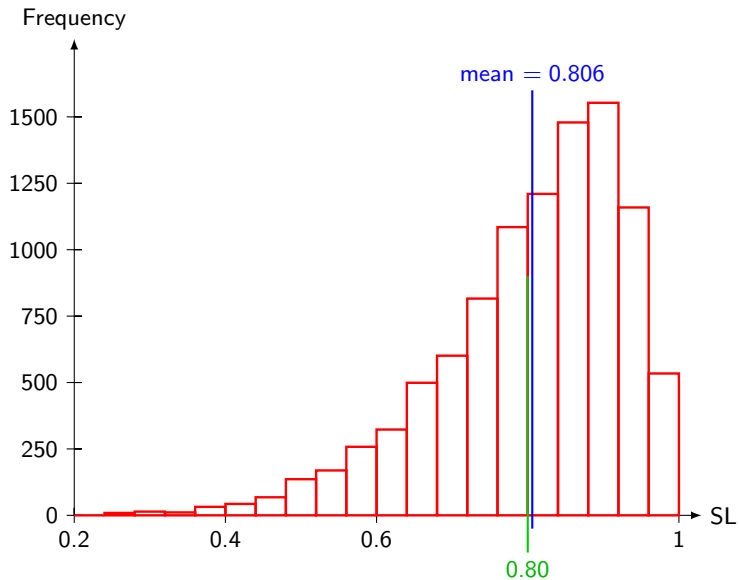

Distribution of SL Period: 17

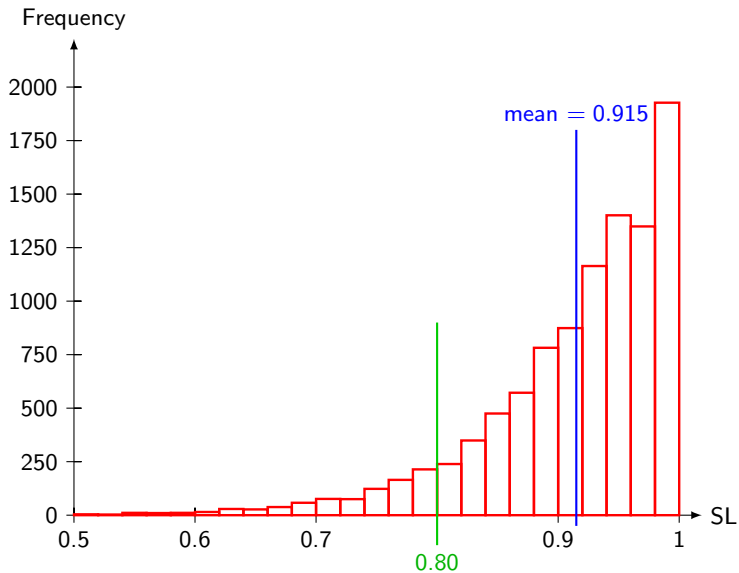

Distribution of SL Period: 11

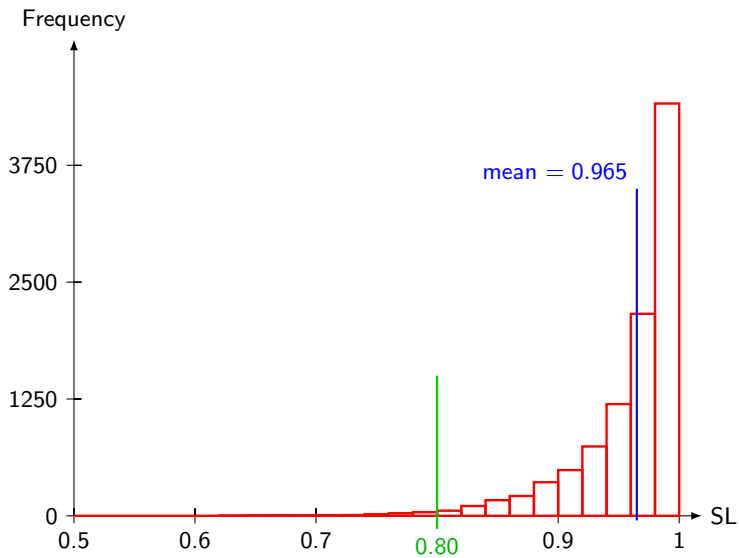

Distribution of SL Period: 49

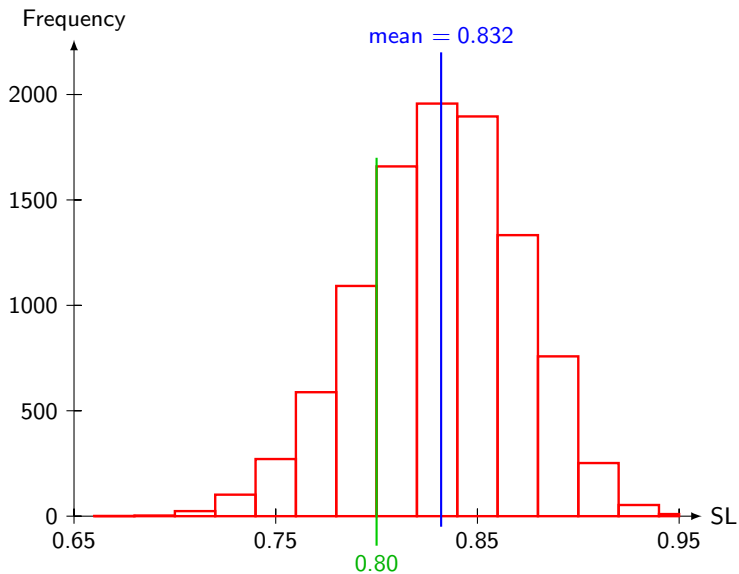

Distribution of SL for Call Type 3

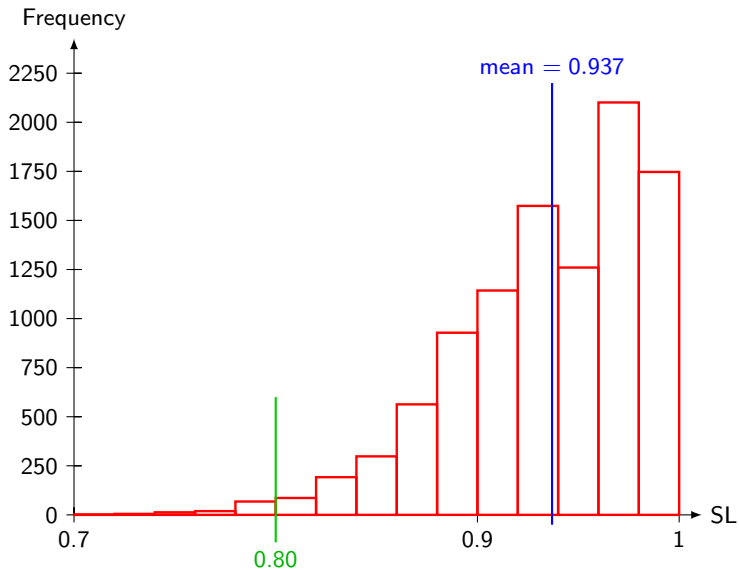

Distribution of SL for Call Type 17

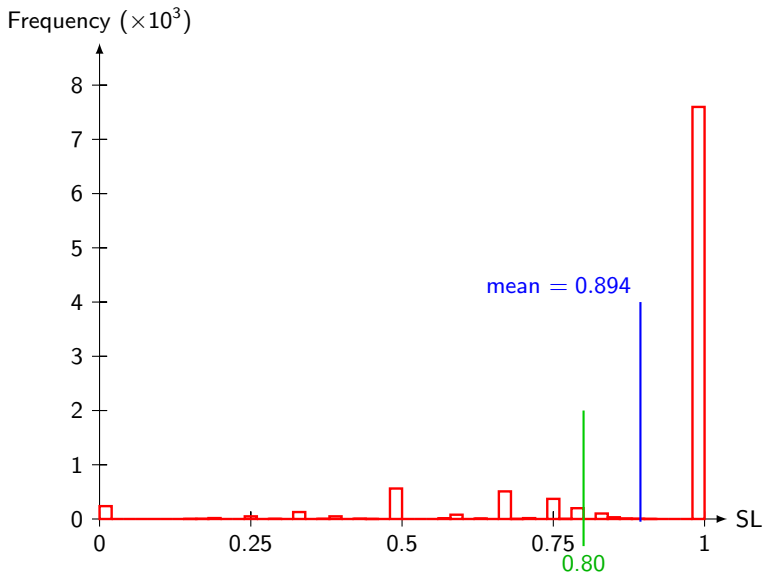

Distribution of SL for Call Type 2 in Period 20

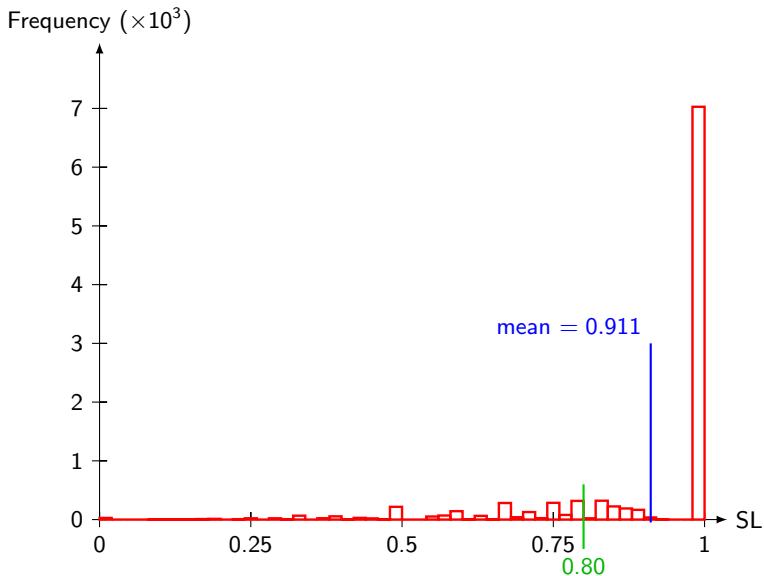

Distribution of SL for Call Type 12 in Period 30

Example of scheduling optimization problem

Suppose the routing rules are fixed.

Several call types, several agent types, several time periods.

Example of scheduling optimization problem

Suppose the routing rules are fixed.

Several call types, several agent types, several time periods.

A **shift type** specifies the time when the agent starts working, when he/she finishes, and all the lunch and coffee breaks.

$c_{s,q}$ = cost of an agent of type s having shift type q .

Example of scheduling optimization problem

Suppose the routing rules are fixed.

Several call types, several agent types, several time periods.

A **shift type** specifies the time when the agent starts working, when he/she finishes, and all the lunch and coffee breaks.

$c_{s,q}$ = cost of an agent of type s having shift type q .

The **decision variables** \mathbf{x} and \mathbf{z} are:

- (i) $x_{s,q}$ = number of agents of type s having shift type q ;
- (ii) $z_{\ell,s,j}$ = number of agents of type ℓ that work as type- s agents in period j , with $S_s \subset S_\ell$ (they use only part of their skills).

This determines indirectly the **staffing** vector \mathbf{y} , where $y_{s,j}$ = num. agents of type s in period j , and $a_{j,q} = 1$ iff shift q covers period j :

$$y_{s,j} = \sum_q a_{j,q} x_{s,q} + \sum_{l \in S_s^+} z_{l,s,j} - \sum_{l \in S_s^-} z_{s,l,j} \quad \text{for all } s, j.$$

Scheduling Optimization Problem

\mathbf{x} = vector of shifts; \mathbf{c} = their costs; \mathbf{y} = staffing vector;
 (Long-run) service level for type k in period j (depends on entire vector \mathbf{y}):

$$g_{k,j}(\mathbf{y}) = \frac{\mathbb{E}[\text{num. calls type } k \text{ in period } j \text{ answered within time limit}]}{\mathbb{E}[\text{num. calls type } k \text{ in period } j, \text{ ans., or abandon. after limit}]}$$

(P0) : [Scheduling problem]

$$\begin{aligned} \min \quad & \mathbf{c}^t \mathbf{x} = \sum_{s=1}^I \sum_{q=1}^Q c_{s,q} x_{s,q} \\ \text{subject to} \quad & \mathbf{A}\mathbf{x} + \mathbf{B}\mathbf{z} = \mathbf{y}, \\ & g_{k,j}(\mathbf{y}) \geq l_{k,j} \quad \text{for all } k, j, \\ & g_j(\mathbf{y}) \geq l_j \quad \text{for all } j, \\ & g_k(\mathbf{y}) \geq l_k \quad \text{for all } k, \\ & g(\mathbf{y}) \geq l, \\ & \mathbf{x} \geq 0, \mathbf{z} \geq 0, \mathbf{y} \geq 0, \text{ and integer.} \end{aligned}$$

Sample-path optimization via simulation

We simulate n independent operating days of the center, to estimate the functions g .

Let ω represent the source of randomness, i.e., the sequence of independent uniform r.v.'s underlying the entire simulation (n runs).

The empirical SL's over the n simulation runs are:

$\hat{g}_{n,k,j}(\mathbf{y}, \omega)$ for call type k in period j ;

$\hat{g}_{n,j}(\mathbf{y}, \omega)$ aggregated over period j ;

$\hat{g}_{n,k}(\mathbf{y}, \omega)$ aggregated for call type k ;

$\hat{g}_n(\mathbf{y}, \omega)$ aggregated overall.

For a fixed ω , these are deterministic functions of \mathbf{y} .

We replace the (unknown) functions $g(\cdot)$ by $\hat{g}(\cdot, \omega)$ and optimize.

To compute them at different values of \mathbf{y} , we use simulation with well-synchronized common random numbers. Discuss.

Empirical (sample) scheduling optimization problem

(SP0_n) : [Sample scheduling problem]

$$\min \mathbf{c}^t \mathbf{x} = \sum_s \sum_{q=1}^Q c_{s,q} x_{s,q}$$

subject to $\mathbf{Ax} + \mathbf{Bz} = \mathbf{y}$,

$$\hat{g}_{n,k,j}(\mathbf{y}) \geq l_{k,j} \quad \text{for all } k, j,$$

$$\hat{g}_{n,j}(\mathbf{y}) \geq l_j \quad \text{for all } j,$$

$$\hat{g}_{n,k}(\mathbf{y}) \geq l_k \quad \text{for all } k,$$

$$\hat{g}_n(\mathbf{y}) \geq l,$$

$$\mathbf{x} \geq 0, \mathbf{z} \geq 0, \text{ and integer.}$$

Theorem: When $n \rightarrow \infty$, the optimal solution of SP0_n converges w.p.1 to that of P0. Moreover, if a standard large deviation principle holds for \hat{g} (which is typical), the probability that the two solutions differ converges to 0 exponentially with n . [Adaptation of Vogel 1994, for example.]

Solving the sample optimization problem

Integer programming with cutting planes.

[Atlason, Epelman, and Henderson, 2004; Cezik and L'Ecuyer 2005]

Replace the nonlinear constraints in $SP0_n$ by a set of linear constraints.

This gives an integer program (IP).

We start with a relaxation of the IP problem (fewer constraints).

Then, at each step, use simulation to compute the service levels in $SP0_n$ for the optimal solution \bar{y} of the current IP.

For each SL constraint that is not satisfied, add a cut based on estimated subgradient.

Stop when all SL constraints of $SP0_n$ are satisfied.

Solving the sample optimization problem

Integer programming with cutting planes.

[Atlason, Epelman, and Henderson, 2004; Cezik and L'Ecuyer 2005]

Replace the nonlinear constraints in $SP0_n$ by a set of linear constraints.

This gives an integer program (IP).

We start with a relaxation of the IP problem (fewer constraints).

Then, at each step, use simulation to compute the service levels in $SP0_n$ for the optimal solution \bar{y} of the current IP.

For each SL constraint that is not satisfied, add a cut based on estimated subgradient.

Stop when all SL constraints of $SP0_n$ are satisfied.

In practice, for large problems, we solve the IP as an LP and round the solution (at each step, to be able to simulate). We select a rounding threshold δ (usually around 0.5 or 0.6). Heuristic!

Solving the sample optimization problem

Integer programming with cutting planes.

[Atlason, Epelman, and Henderson, 2004; Cezik and L'Ecuyer 2005]

Replace the nonlinear constraints in $SP0_n$ by a set of linear constraints.

This gives an integer program (IP).

We start with a relaxation of the IP problem (fewer constraints).

Then, at each step, use simulation to compute the service levels in $SP0_n$ for the optimal solution \bar{y} of the current IP.

For each SL constraint that is not satisfied, add a cut based on estimated subgradient.

Stop when all SL constraints of $SP0_n$ are satisfied.

In practice, for large problems, we solve the IP as an LP and round the solution (at each step, to be able to simulate). We select a rounding threshold δ (usually around 0.5 or 0.6). Heuristic!

Phase II: run longer simulation to perform a local adjustment to the final solution, using heuristics (add, remove, switch).

Other objectives and constraints (alternative formulations)

Chance constraints: Replace long-term average $g_{k,j}(\mathbf{y})$ by a tail probability of the service level, e.g.:

$$\mathbb{P}[\text{SL}_{k,j}(\tau) \geq l_{k,j}] \geq \alpha_{k,j} \quad \text{for all } k, j.$$

Other objectives and constraints (alternative formulations)

Chance constraints: Replace long-term average $g_{k,j}(\mathbf{y})$ by a tail probability of the service level, e.g.:

$$\mathbb{P}[\text{SL}_{k,j}(\tau) \geq l_{k,j}] \geq \alpha_{k,j} \quad \text{for all } k, j.$$

Optimizing call routing rules.

Replace constraints by penalties.

Etc.

Conclusion

Simulation can be useful only to the extent that we can trust the model.

We can do more and more runs and compute arbitrarily tight confidence intervals on certain unknown quantities, but this can be meaningless if the model is not accurate enough.

Huge masses of data are becoming available (currently) at a rate never seen before and that increases exponentially. Exploiting this data to build credible and valid stochastic models of complex systems is in my opinion the biggest challenge that we now face for simulation.